



**MINIMUM STANDARDS
FOR THE CONSTRUCTION OF
SUBDIVISION ROADS AND STREETS**

**DEPARTMENT OF TRANSPORTATION
AND INFRASTRUCTURE**

PROVINCE OF NEW BRUNSWICK

APPROVED BY: 
MINISTER OF TRANSPORTATION
AND INFRASTRUCTURE

Fredericton, May 2017

FOREWORD

A guide to the “Minimum Standards for the Construction of Subdivision Roads and Streets” was first published in 1976, revised in 1992, 1996 and 2003. This edition of the guide reflects changes in matters that affect subdivision roads and streets in unincorporated areas of the province, including current engineering and environmental practices, regulations, and government policies. The guide has also been reorganized to more closely reflect the process in which the subdivision approval process follows. References to relevant legislation, regulations and policies have been added where appropriate.

The purposes of the Minimum Standards contained within this document are to develop safe and efficient streets that will effectively serve the various land uses in unincorporated areas of the Province of New Brunswick., and to ensure good highway development. Adherence to these Minimum Standards will help to ensure consistency is applied in the approval process for the construction and acceptance of subdivision roads and streets. The authority to require the construction of roads and streets to meet certain prescribed minimum standards is vested in the Minister of Transportation and Infrastructure by the Community Planning Act, R.S.N.B. 1973, Chapter C-12 and amendments thereto.

The requirements prescribed in this guide are minimum standards which must be met or exceeded in the construction of subdivision roads and streets. However, the Minister of Transportation and Infrastructure may specify higher standards where required by the circumstances of a particular development.

Table of Contents

Page

Foreword	(iii)
1.0 INTRODUCTION	1
2.0 DEFINITION OF TERMS	3
2.1 Acronyms	11
2.2 Roles and Responsibilities	11
3.0 OVERVIEW OF SUBDIVISION APPROVAL PROCESS	13
Process Flowchart	16
4.0 TENTATIVE SUBDIVISION PLAN PHASE	17
4.1 Review and Approval of Tentative Plan	17
4.2 Required Contents of the Tentative Plan	18
4.3 Street Layout Standards	20
4.3.1 General	20
4.3.2 Access	21
4.3.3 Grid Pattern	22
4.3.4 Cul-de-sacs	23
4.3.5 P-Loops	24
4.3.6 Intersecting Streets	24
4.3.6.1 General	24
4.3.6.2 Intersection Spacing	25
4.3.7 Sight Distance Requirements	25
4.3.7.1 Street Intersections	25
4.3.7.2 Driveway Accesses	25
4.3.7.3 Subdivision Street Intersection with Local, Collector or Arterial Highway	26
4.3.8 Lots, Blocks and Other Parcels	26
4.3.9 Street Names	27
4.3.10 Future Streets	27

Table of Contents (cont'd)

Page

5.0 SUBDIVISION DESIGN AND DRAINAGE PHASE	28
5.1 Subdivision Design Approval	28
5.2 Street Design	28
5.2.1 Horizontal and Vertical Alignment	28
5.2.2 Street Widths	29
5.2.3 Gradient	29
5.3 Drainage Study and Design.....	30
5.3.1 Drainage Study	30
5.3.2 Municipal Services Easements for Drainage Purposes	31
5.3.3 Attenuation Ponds	32
5.3.4 Storm Sewers	32
5.4 Culverts	32
5.4.1 General	32
5.4.2 Subdivision Entrance Culverts	33
5.4.3 Street Cross Culverts	33
5.4.4 Driveway Culverts.....	33
5.5 Serviced Subdivisions	33
5.6 Environmental Permitting	33
6.0 SUBDIVISION CONSTRUCTION PHASE	34
6.1 Construction Inspections and Approvals	34
6.2 Construction Schedule	35
6.3 Construction of Streets	35
6.3.1 Clearing	35
6.3.2 Grubbing	35
6.3.3 Grading	35
6.3.4 Aggregate Subbase.....	36
6.3.5 Aggregate Base	37
6.3.6 Finished Grade	37
6.3.7 Guide Rail and Posts	38

Table of Contents (cont'd)	Page
6.3.8 Tack Mulching or Hydroseeding	38
6.4 Changes to Approved Design or Drainage	38
7.0 FINAL SUBDIVISION APPROVAL PHASE	39
7.1 Requirements for Approval	39
7.2 Approval by the Minister of Transportation and Infrastructure	40
7.3 Final Approval of Subdivision	41
Appendix A PLAN VIEWS	42
Figure A1 Cul-de-Sac Layout	43
Figure A2 Cul-de-Sac Turning Circle	44
Figure A3 Temporary Cul-de-Sac	45
Figure A4 Turnaround Area for Hammerhead Cul-de-Sac	46
Figure A5 Turnaround Area for Modified Hammerhead Cul-de-Sac	47
Figure A6 P-Loop Standard	48
Figure A7 Intersection Alignment – No Control Line	49
Figure A8 Intersection Alignment for Highway Subject to Control Line	50
Figure A9 Road Intersection Spacing (including Table A9)	51
Figure A10 Right-of-Way Limits at Intersections	52
Table A11.1 Stopping Sight Distance	53
Table A11.2 Turning Sight Distance	53
Figure A12 Sag & Crest Curve Minimum Vertical Curve Length	54
Appendix B PROFILE AND CROSS-SECTION VIEWS	55
Figure B1 Non Curbed Local Highway	56
Figure B2 Residential Streets Serviced Local	57
Figure B3 Profile of Minor Road	58
Figure B4 Entrance Culvert & Cross Culvert	59
Figure B5 Standard Driveway Culvert	60
Appendix C DRAINAGE	61
Hydraulic Capacity of Culvert Design - Department of Transportation and Infrastructure	62
Design Chart 2.31 Inlet Control – Circular Pipes	64
Attenuation Pond Criteria for Rural Subdivision Development Drainage Design	65
Appendix D TRANSPORTATION DISTRICTS AND CONTACT INFORMATION	67
Map of Department of Transportation and Infrastructure Districts	68
Department of Transportation and Infrastructure District Contact Information	69

1.0 INTRODUCTION

The purpose of the Minimum Standards contained within this document is to promote the development of streets, which will effectively serve the various land uses in the unincorporated areas of New Brunswick. The Minimum Standards are also intended to ensure the proper development and construction of this part of the provincial highway system and are to be used as a guide for county projects.

The Community Planning Act, R.S.N.B. 1973, Chapter C-12 and amendments thereto, vests the Minister of Transportation and Infrastructure with the authority to require the construction of roads and streets to meet certain prescribed Minimum Standards. The construction requirements embodied in the Minimum Standards are, to a large extent, those prescribed by Provincial legislation and enhanced by experienced planning, maintenance and construction engineers familiar with New Brunswick's topography and climate. The Minimum Standards contained within this guide are intended to ensure the safety of the public and road users, to protect the interests of present and future lot owners and to promote the development of efficient streets which will effectively serve the various land uses in unincorporated areas of the province.

In accordance with Section 55 of the Community Planning Act, the Minimum Standards must be adhered to in the construction of public roads and streets in all areas of the province outside of municipal boundaries as a condition of approval and acceptance of the streets by the Minister of Transportation and Infrastructure.

The Minimum Standards apply to all of the unincorporated areas of the province in:

- (i) the planning, design, drainage and construction of new public and future streets;
- (ii) the reconstruction or upgrading of existing unserviceable or inadequate public streets; and
- (iii) the conversion of private streets (access roads) to public streets.

In cases where the Minimum Standards need to be expanded or additional specifications are required, the "Geometric Design Guide for Canadian Roads" as published by the Transportation Association of Canada, as well as the latest versions of the Department of Transportation and Infrastructure's "Standard Specifications" and "Environmental Management Manual" shall be used for guidance.

DTI's review for compliance with the Minimum Standards considers the overall subdivision potential with regard to street layout, the further subdividing of land or adjoining land, the general topography, present and potential challenges with drainage, the interest of future lot owners and the general public, as well as the maintenance provided to and the serviceability of existing roads leading to the proposed subdivision.

Substandard roads that provide access to a proposed subdivision must be constructed or upgraded to meet the requirements of the Minimum Standards. These include, but are not limited to roads classified as public non-maintained in unincorporated areas that are not serviceable as highways under the Highway Act, and are evaluated similarly to any street to be constructed in a subdivision. More detailed information concerning streets in subdivisions and the designation of roads may be obtained from:

Property Services Branch
Department of Transportation and Infrastructure
440 King Street, Fredericton NB
(506) 453-3939

or from the District Transportation Engineer in your area. A map of New Brunswick showing each Transportation District is included in Appendix D.

2.0 DEFINITION OF TERMS

The following definitions are for use in conjunction with this guide only:

"**ACT**" means the Community Planning Act, R.S.N.B. 1973, Chapter C-12 and amendments thereto.

"**AGGREGATE BASE**" or "**base**" means the layer of crushed aggregate placed as a distinct layer directly below the all-weather surface.

"**AGGREGATE SUBBASE**" or "**subbase**" means the layer of aggregate placed as a distinct layer between the Aggregate Base and the Borrow 'A'/A1' layer.

"**ALL-WEATHER SURFACE**" or **driving surface, or paved surface**, means the chip seal or asphalt surface of the road.

"**ARTERIAL HIGHWAY**" means a road intended to move a relatively large volume of traffic at medium to high speeds and includes a highway classified by the Minister of Transportation and Infrastructure as an arterial highway under Section 14 of the Highway Act and all highways assigned a route number from 1 to 99 or given a name. Arterial highways are used where traffic movements are the primary consideration and land access is secondary. Arterial highways may be subject to control line and/or controlled access regulation.

"**CERTIFICATE OF SETBACK**" means a certificate issued in accordance with a by-law or regulation established under the Community Planning Act. The certificate must be signed by the applicant and countersigned by the Development Officer (for land within an unincorporated area) or the District Transportation Engineer having jurisdiction (for land outside of an unincorporated area).

"**COLLECTOR HIGHWAY**" means a road intended to collect traffic from local streets and land-access roads and includes a highway classified by the Minister of Transportation and Infrastructure as a collector highway under Section 14 of the Highway Act and all highways assigned a route number from 100-199 or given a name. Collector highways are used where traffic movement and land access are of approximately equal importance. Collector highways may be subject to control line and/or controlled access regulation.

"CONSULTANT ENGINEER" is a Professional Engineer, registered to practise in the province of New Brunswick, who is responsible for the design, supervision, regular inspection and the quality control of the construction of the new streets and associated infrastructure within a proposed subdivision. He/she must ensure that the work is carried out in accordance with the approved Engineering Design Plans and meets or exceeds DTI standards. The consultant engineer will be required to provide stamped documentation guaranteeing compliance with DTI standards.

"CONTROL LINE" means a line offset from and normally, but not always, running parallel to the centreline of an arterial or collector highway. A control line shall not be more than 180 metres from the centre of the highway right-of-way. A control line creates a land use restriction pursuant to Section 65 of the Highway Act.

"CONTROLLED ACCESS" means land access control under Section 38 of the Highway Act; imposes land access restriction only, does not affect use of the land; any means intended for or capable of providing access to such highway is prohibited, subject to obtaining a permit from the Minister of Transportation and Infrastructure allowing conditional access.

"CONTROLLED ACCESS HIGHWAY" means a highway, which has been designated to be a controlled access highway pursuant to Sections 38 of the Highway Act.

"CUL-DE-SAC" means a road or street that is closed at one end thereby having only one access to/from another road, street or highway.

"DEPARTMENT OF TRANSPORTATION AND INFRASTRUCTURE" (DTI) means the Department of Transportation and Infrastructure, Province of New Brunswick.

"DEVELOPER" means a person undertaking a development and includes a landowner or authorized agent submitting a subdivision plan.

"DEVELOPMENT" means:

- a) the erecting, placing, relocating, removing, demolishing, altering, repairing or replacing of a building or structure other than utility poles and wires, traffic control devices or statutory notices;

- b) where the purposes for which land, buildings and structures may be used are set out in a regional, municipal or area plan, basic planning statement, development or urban renewal scheme or zoning by-law or regulation, any change in the purpose for which any land, building or structure affected thereby is used;
- c) any excavation of sand, gravel, clay, shale, limestone or other deposit for a development mentioned in (a) or for purposes of the sale or other commercial use of the material excavated; or
- d) the making of land by cutting or filling to a depth in excess of one metre.

"DRAINAGE DITCH" means an artificially constructed open depression for the purpose of carrying off surface water.

"DRAINAGE STUDY" documents the existing drainage patterns and the topography of adjacent lands, subdivisions, etc., as well as the infrastructure in place for the existing drainage system (culvert size, ditch grades, etc.) and is an integral part of the design of subdivision streets. The Drainage Study must show where the water goes after it has been drained from the subdivision and indicate if attenuation is required.

"DRIVEWAY" means a private roadway used to provide access from a road, street or highway to abutting lands. Approval for new driveways is subject to DTI's Access Point Policy.

"ENGINEERING DESIGN PLAN" means a document prepared by a Professional Engineer which geometrically defines the road within the road right-of-way and proposed drainage infrastructure.

"FILED SUBDIVISION PLAN" means a subdivision plan approved by a Development Officer under the Community Planning Act, or a Planning Commission under a previous Act, which has been filed in the Registry Office and includes a subdivision plan filed in the Registry Office when there was no subdivision by-law or regulation under the Community Planning Act or a previous Act applicable to the land comprised in the plan.

"FINISHED GRADE" means the grade to indicate the finished pavement elevation of the road centreline.

"FUTURE STREET" means a parcel of land, delineated on a subdivision plan as a "Future Street", which is to be used as a street at some date in the future. The title to the land vests in the Crown (Province of New Brunswick) upon the filing of the subdivision plan.

"HIGHWAY" means the whole strip of land bounded by the right-of-way boundaries, which is reserved for the use of the travelling public, and for the purpose of constructing and maintaining the roadway and its appurtenances and includes a road, street or common public road designated by the Minister of Transportation and Infrastructure under Section 15 of the Highway Act to be a highway.

"HIGHWAY USAGE PERMIT" or "HUP" means a document issued by the Department of Transportation and Infrastructure permitting the holder and persons acting under authority of the permit to carry out work as outlined in Section 44.1(9) of the Highway Act.

"INSPECTION" means continuous field inspection by the Consultant Engineer or periodical field inspection by the Department of Transportation and Infrastructure, District Transportation Engineer or their designate.

"LAND FOR PUBLIC PURPOSES" means land, other than streets, for the recreational or other use and enjoyment by the public and includes:

- (a) An access to a lake, river, stream, sea or other body of water;
- (b) A beach or scenic area along the shore of a lake, river, stream, sea or other body of water;
- (c) A conservation area;
- (d) Land adjoining a school, for joint recreational purposes;
- (e) Land for a community hall, public library, recreational use or other similar community facility;
- (f) Open space, to provide air and light, to afford a view to or from a development or to a lake, river, stream, sea or other body of water, or for other purposes;
- (g) A park, green belt or buffer area dividing developments, parts of a highway or a development and a highway;
- (h) A pedestrian way to a school, shopping centre, recreational area or other facility;
- (i) A protection area for a watercourse, stream, marsh, water supply, lake or other body of water;

- (j) A public park, playground or other recreational use;
- (k) A visual feature; or
- (l) A wooded area, slope area or a site giving view to a scenic area to provide diversity.

Pursuant to the Community Planning Act, land for public purposes located in unincorporated areas of the province vests in the Crown.

“LAND SURVEYOR” means a person licensed by the Association of New Brunswick Land Surveyors to carry out professional land surveying services. He/she will research, identify and map existing and proposed property boundaries, and other required information to generate the legal plans for the creation of the new subdivision.

"LOCAL HIGHWAY" means a highway classified by the Minister of Transportation and Infrastructure as a local highway and includes a highway classified under Section 14 of the Highway Act as a local highway, as well as all highways assigned a route number greater than 199 or given a name and classified as A or B. Local highways are primarily intended to provide land access and may be subject to controlled access regulation.

"MINIMUM STANDARDS" means the standards prescribed by the Minister of Transportation and Infrastructure for the construction of public roads and streets.

"MINISTER" means the Minister of Transportation and Infrastructure.

"MUNICIPAL SERVICES EASEMENT (MSE) FOR DRAINAGE PURPOSES" means a strip of land vested in the Crown which grants the Minister of Transportation and Infrastructure legal rights to use the property of another for drainage purposes including the right to construct, maintain and repair a drain for the carrying of water, either on the surface of the land or through buried pipes.

“PARCEL IDENTIFICATION NUMBER (PID)” means an identification number assigned by Service New Brunswick to each parcel of land which is used to locate the land, and record land titles and interests in the land.

“PAVEMENT” means the surface and/or base mixes whether concrete, asphalt or chip seal.

"P-LOOP" means a relatively short street that has a more or less circular loop at one end with significant non-street land in its centre; closes back on itself and has only one point of access to another street.

"PRIVATE STREET" means a parcel of land, commonly delineated on a subdivision plan as an "Access Road", on which an access has been constructed for private use. Title to the land is not held by the Crown. The Department of Transportation and Infrastructure is not responsible for maintenance or repairs to private streets.

"PROFESSIONAL ENGINEER" means a person who is a registered member of the Association of Professional Engineers and Geoscientists of New Brunswick and licensed to practice engineering in New Brunswick (see also "Consultant Engineer").

"PROVINCIAL SUBDIVISION REGULATION" means the Provincial Subdivision Regulation or By-Law, Community Planning Act, as amended from time to time. The Regulation or By-Law is promulgated under the Community Planning Act, R.S.N.B. 1973, Chapter C-12, and amendments thereto.

"PUBLIC STREET" includes a parcel of land, delineated on a subdivision plan as a "Public Street", on which a street for public use has been constructed in accordance with standards prescribed and accepted by the Minister of Transportation and Infrastructure as a public street. Title to the land is vested in the Crown.

"PUBLIC UTILITIES EASEMENT (PUE)" means a strip of land used to place and provide access to utilities by power commissions and telecommunications companies.

"RECREATIONAL SUBDIVISION" means the subdivision of land for the primary purpose of recreational enjoyment on a seasonal basis as opposed to use and enjoyment on a year-round or continuous basis. Recreational subdivisions must be approved and constructed to standards set by the Regional Service Commission and/or the Department of Transportation and Infrastructure. The Department of Transportation and Infrastructure is not responsible for maintenance or repairs to recreational subdivision streets.

“REGIONAL SERVICE COMMISSION” or **“RSC”** means the planning body established under the Community Planning Act to approve the subdivision and development of land.

"RIGHT-OF-WAY" means those portions of land constructed, maintained and reserved for the public as a highway under the administration and control of the Minister of Transportation and Infrastructure.

"ROADBED" means that portion of the road course between the inside edges of slopes of ditches and fills.

"ROADWAY" means, for a street with curbs and gutters, that portion of the finished street surface between the outside lines of gutters; and for a street with open ditches, that portion of the finished street surface between the outside edges of the shoulders; in all instances, that part of a street designed, constructed, maintained or intended for physical contact by traffic in the course of normal passage and use.

"SETBACK LINE" means a line drawn parallel to the boundary of a highway or village street, which is located at the setback distance required by the Provincial Set-back Regulation or By-Law.

"STREET" means the entire width between the boundary lines of a street, road or highway and includes a public thoroughfare in an urban setting with buildings or residential dwellings more or less continuously housed on each side of it along its limits.

"STRUCTURE" means a bridge, culvert, catch basin, drop inlet, retaining wall, cribbing, manhole and wall, building, sewer, service pipe, under drain, foundation drain and other features which may be encountered in the construction of the road and not otherwise classed herein.

“SUBBASE” means the granular, gravel or crushed rock aggregate placed immediately above the subgrade.

"SUBDIVIDE" means to divide a parcel of land into two or more parcels.

"SUBDIVISION" means a parcel of land which has been subdivided.

"SUBDIVISION LOT" means a subdivided part, parcel or lot of land depicted on, created by, and identified as a separate and individual lot on a filed subdivision plan.

"SUBDIVISION PLAN" means a plan of survey prepared and certified to be correct by a registered New Brunswick Land Surveyor by which a parcel of land is being subdivided.

"SUBGRADE" means the prepared earth or rock surface parallel to the finished grade upon which the aggregate base or subbase material is to be placed, or the grade line to indicate the finished elevation of the centreline of subgrade.

"SURETY" means a bank draft or a certified cheque required as a guarantee to the Minister of Transportation and Infrastructure ensuring the subdivision streets and associated infrastructure will be constructed in accordance with these Minimum Standards.

"TENTATIVE PLAN" means a provisional plan of the proposed subdivision prepared by a New Brunswick Land Surveyor in compliance with the requirements of the Community Planning Act.

"UNINCORPORATED AREA" means those areas of the province lying outside the municipal boundaries of cities, towns and villages, rural communities and rural municipalities.

"WORK AREA TRAFFIC CONTROL MANUAL" or **"WATCM"** provides a uniform set of traffic control guidelines for all work carried out on New Brunswick provincial roads. Any work that occurs within the right-of-way of a provincial road must conform to the guidelines prescribed by this manual.

2.1 Acronyms

DTE – District Transportation Engineer
DTI – Department of Transportation and Infrastructure
DELG – Department of Environment and Local Government
EMM – Environmental Management Manual
HUP – Highway Usage Permit
MSE – Municipal Service Easement
OGD – Other Government Departments
PID – Parcel Identification Number
PSB – Property Services Branch
PUE – Public Utilities Easements
RSC – Regional Service Commission
SNB – Service New Brunswick
WATCM – Work Area Traffic Control Manual
WAWA - Watercourse and Wetland Alteration Permit

2.2 Roles and Responsibilities

Regional Service Commission: The RSC has overall responsibility for rural subdivision approval in accordance with the provisions of the Community Planning Act and its Regulations. The RSC ensures that the tentative subdivision plan contains all the information required for review by DTI and other government departments. The RSC also consults with DTI to identify the requirements of the final legal plan. The RSC prepares the letter recommending final approval of new public streets by the Minister, and issues its approval to file the final plan in the registry office.

Department of Transportation and Infrastructure: The role of Property Services Branch (PSB) of DTI is to review all tentative subdivision plans, drainage, design, and final legal plans and documents submitted for approval to ensure requirements and minimum standards as outlined in this document are met. Departmental staff assist PSB in the analysis of the drainage and design plans, perform periodic quality assurance inspections during construction, carry out a final inspection, and prepare surety deposit requirements.

Consultant Engineer: The role of the consultant engineer is to ensure that the design and construction of the subdivision meets or exceeds the Department’s standards. The consultant engineer is also responsible for all quality control measures during street and drainage construction. He/she must prepare and stamp appropriate documentation guaranteeing compliance with DTI standards. It is the Developer’s responsibility to submit the stamped documents to the Department.

When the Property Services Branch has received the documents of guarantee from the consultant engineer and reviewed the final plan with the Development Officer, the Developer may submit the plan to the RSC who will forward it to DTI’s Property Services Branch for approval. Only those streets and easements included within the heavy dark line on the plan are affected by the assent of the Minister of Transportation and Infrastructure, regarding the vesting of title in streets and easements to the Crown.

At the Tentative Plan approval phase, Sight Distance Inspection Reports are the responsibility of the parties as shown below:

Subdivisions that create...	Responsibility:
“Private Streets” or “Lots” along an existing DTI highway...	Developer / Land Surveyors / Consultant Eng. / Planning Commissions, etc.
“Public Streets”...	Same as above... but District Inspectors audit.

3.0 OVERVIEW OF SUBDIVISION APPROVAL PROCESS

The subdivision approval process essentially consists of four approval phases. The approval process diagram on page 16 illustrates the Department of Transportation and Infrastructure's approval process policy and is further described below:

1. The first phase in the approval process is the preparation of a tentative subdivision plan, unless the type of subdivision proposed by a Developer is exempted under the Community Planning Act from submitting a filed subdivision plan. The tentative plan must be prepared by, or under the direct supervision of, a New Brunswick Land Surveyor. The completed tentative plan and other required documentation is forwarded to the Development Officer of the Regional Service Commission, who then sends a copy of the plan to other government departments (OGD) for their consideration.

When the Development Officer forwards a copy of the tentative plan to the Minister of Transportation and Infrastructure, the Property Services Branch coordinates the review of submitted documents with the District Transportation Engineer and Design Branch for the general suitability of proposed public roads or streets. **The Developer is responsible for obtaining approval of all proposed street names.** Any additional or missing information as outlined in the Community Planning Act or requested by the Department shall be submitted before a recommendation for approval to the Development Officer will be given.

The recommendation for approval of the tentative plan by the Department of Transportation and Infrastructure to the Development Officer is null and void at the expiration of one year from the day of the recommendation. Similarly, the approval of a tentative plan is null and void at the expiration of one year from the day of its approval by the Development Officer. Re-application after the original approval period lapses will be necessary and compliance with any updated requirements for subdivision roads will apply.

2. When the required parties have recommended approval of the tentative subdivision plan and where a public street is being created, the Department will require the submission of engineering design drawings together with a drainage report and drainage plan for review. These documents shall be stamped by a professional engineer. No further approvals will be given prior to their receipt. These documents are required for DTI review and formal approval before any construction takes place. When the engineering design and drainage plans have

been approved, the Developer may proceed with the layout and construction of the streets and drainage infrastructure in accordance with the approved plans.

Approval of design and drainage plans expires two years from the date of issue. The Developer shall resubmit expired design and drainage plans to DTI for review and reapproval. Inspection of all construction is to be based on currently approved plans. This ensures the most current engineering and construction standards and practices are being applied to new roads and drainage infrastructure.

Prior to beginning construction, the Developer shall contact the District Transportation Engineer, advise DTI of their proposed construction schedule, and submit the names and contact info of the Developer's consultant engineer. Such representatives are considered to have authority and accountability on behalf on the Developer.

3. During construction, the Developer's consultant engineer will perform ongoing quality control inspections to ensure compliance with the minimum standards and approved plans. The Developer's consultant engineer shall keep a weekly inspection log with site visit notes which is to be submitted to DTI upon request. The District Transportation Engineer will carry out periodic quality assurance inspections at key stages during the construction. When the construction of the road subgrade, base, ditching, cross-culverts, municipal services easements for drainage and any turnaround areas has been completed, inspected and approved by the District Transportation Engineer, the Developer may proceed with the final street construction or posting a surety guaranteeing final street construction in accordance with the minimum standards.

Please note that any work being done within an existing DTI right-of-way must meet the Work Area Traffic Control Manual (WATCM) Safety Standards. Consult the WATCM website for more information.

The consultant engineer must submit as-built drawings or prepare and stamp appropriate documentation certifying compliance with DTI standards. **It is the Developer's responsibility to submit these documents to the Department.** Other documentation including source approvals, sieve analysis, compaction test results and environmental permits may be required. Once the Department of Transportation and Infrastructure's Property Services Branch have received these documents of guarantee, the Developer may proceed with the preparation of the final plan.

4. **A draft copy of the final plan is submitted to the Development Officer, the District Transportation Engineer and to Property Services Branch.** When the draft copy is approved by these parties, the Developer may proceed with preparing the required number of final subdivision plans. When all required signatures and regulatory approvals are obtained, the Developer shall forward the plans to the development officer, who will then forward the plan to the Department of Transportation and Infrastructure with a letter recommending assent by the Minister. Only those streets and easements included within the black line of greater weight on the plan are affected by the approval or assent of the Minister of Transportation and Infrastructure, regarding the vesting of title to the Crown.

When the Minister has assented to the plans, they are returned to the development officer for final approval. The Developer may then file the plans in the appropriate registry office thereby allowing lots to be sold. The Department then updates its highway mapping databases, oversees the completion of all outstanding construction and administers associated surety finds.

For scheduling purposes, the Developer is advised that the entire approval process may require from six months to two years for completion, depending on the nature and complexity of the proposed development. Delays caused from lack of information or reworking of design and drainage plans may result in expiration of the tentative plan approval period (one year), requiring reapproval by DTI and the Regional Service Commission. During this time, these Minimum Standards and legislation may change, risking an increase in costs in completing the development.

DEPARTMENT OF TRANSPORTATION INFRASTRUCTURE
RURAL SUBDIVISION APPROVAL PROCESS
(Creation of New Public Streets)

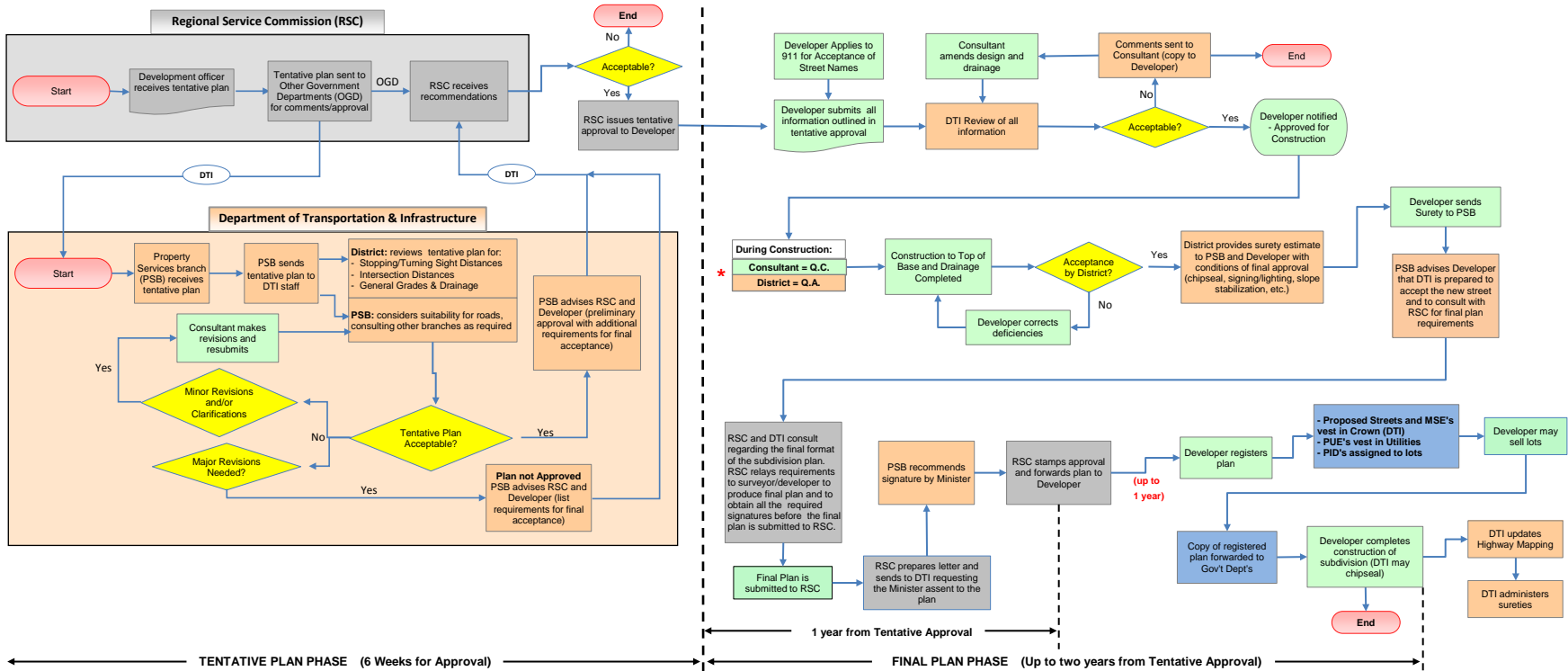

Legend (action to be taken by):

Regional Service Commission	DTI	- Consultant - Developer - Surveyor	SNB
-----------------------------	-----	---	-----

Date of last Revision: May 30, 2014

* Q.C. = Quality Control: full adherence to quality and design during construction
* Q.A. = Quality Assurance: periodic inspections by DTI staff during construction and final inspection report.

4.0 TENTATIVE SUBDIVISION PLAN PHASE

4.1 Review and Approval of Tentative Plan

Before the Minister of Transportation and Infrastructure assents to a subdivision plan under the Community Planning Act, the Regional Service Commission must consider the tentative plan and recommend the location of any public or future streets shown on the plan.

In addition to satisfying the requirements of the Regional Service Commission, a subdivision plan must comply with the minimum standards contained within this document before the Minister of Transportation and Infrastructure will assent to the subdivision plan. The Community Planning Act gives the Minister of Transportation and Infrastructure the authority to prescribe minimum standards for the construction of public streets within a subdivision.

The Department of Transportation and Infrastructure becomes involved with proposed subdivisions, which involve:

- (i) the laying out of new public or future streets and accesses in an unincorporated area;
- (ii) the conversion of a private street (access road) located in an unincorporated area to a public street; or
- (iii) the creation of a lot(s) or private accesses abutting a class PB highway (a public highway which is not included for regular maintenance in the Department's official list of designated highways).

In the above cases, the Development Officer forwards a copy of the Tentative Plan to the Property Services Branch of the Department of Transportation and Infrastructure. The Property Services Branch forwards the tentative plan to the appropriate District Transportation Engineer. The tentative plan is reviewed by the Department of Transportation and Infrastructure based on "THE MINIMUM STANDARDS FOR THE CONSTRUCTION OF SUBDIVISION ROADS AND STREETS" and accepted engineering standards. The District Transportation Engineer may audit a site inspection per the tentative plan requirements including sight distances, intersection distances, general grades and drainage, etc. The Property Services Branch consults with the DTE and other branches as required to determine suitability for the proposed new roads.

The Department may require additional information, such as detailed soil tests, centerline profiles, proposed grades, cross sections, street design, etc., before making a recommendation to the Development Officer. Any requests by DTI for clarifications or minor revisions to the tentative plan must be completed by a registered Professional Engineer or New Brunswick Land Surveyor, as the case requires, and resubmitted for further review.

The Department of Transportation and Infrastructure will evaluate the proposed streets shown on the tentative subdivision plan based on the information provided and an on-site inspection of the property. The Department of Transportation and Infrastructure has three options:

- a) to recommend the proposed location of the streets as shown on the tentative plan;
- b) to recommend the proposed location of the streets as shown, with terms and conditions attached; or
- c) to reject the proposed location of the streets, with an option for offering alternatives.

The Department's Property Services Branch may recommend approval of the tentative plan to the Development Officer subject to certain conditions. It will reply to the Development Officer with its comments within four weeks from the date in which the tentative plan is received. The approval time may exceed this estimate should there be multiple revisions, incomplete information and resubmissions required.

4.2 Required Contents of the Tentative Plan

The Community Planning Act requires that a tentative plan shows certain information concerning the proposed subdivision of the land. The information is necessary for the proper consideration and assessment of the proposed development. The information is used by several government departments to assess the overall subdivision potential of the area with respect to the street layout, the future subdividing of the land or adjoining lands, present and future problems with water drainage, the interests of future lot owners and the condition of and the maintenance provided to existing roads leading to the proposed subdivision.

The tentative plan shall be prepared by a New Brunswick Land Surveyor. Hand drawn plans or sketches will not be acceptable.

In addition to the provisions of the Community Planning Act, the Department of Transportation and Infrastructure requires the following additional data to aid in the assessment process:

- a) such contours and elevations as may be necessary to determine the grade of existing highways, the grade of the proposed new streets and the location of necessary drainage ditches as well as the general drainage pattern and flow direction;
- b) stopping and turning sight distances at the point of access of new streets to the existing highway, as well as the proposed internal streets. Sight distances must be shown on the tentative plan or in document form;
- c) centreline geometry and right-of-way width of the proposed public street(s);
- d) the location of existing control lines, control access or similar zoned land use restrictions along major highways;
- e) the true shape, dimensions and property lines of the Developer's parcel of land being subdivided;
- f) explanation of extra width of street right-of-way for a cut or fill and type of soil involved;
- g) identification on the plan of any areas subject to spring flooding;
- h) a grid north or magnetic north arrow marked on the face of the plan as well as in small key plan;
- i) existing land use of immediately adjacent property showing buildings, fields, streams, rivers, swamps, wooded areas, and areas subject to flooding;
- j) the name, address and telephone number of the New Brunswick Land Surveyor, or the person who prepared the plan under the supervision of same;
- k) the name of the owner/Developer of the land being subdivided, his or her mailing address, email address (if applicable), phone number, and the Parcel Identification Number (PID) for the land being proposed for subdivision;
- l) the distance, in metres, between the centerlines of the nearest existing Public/Private streets to the proposed street(s).
- m) show radius of turns within the tentative plan;

- n) subdivision name and phase number must comply with any previous phase. The subdivision name shall not change throughout the review process.
- o) for proposed access, give the distance from a visible reference point (adjacent driveway, road or building structure);
- p) indicate the distance, in metres, from the end of a curve to the street's intersection with an existing or proposed street as well as the total length of each proposed street;
- q) dimensions of cul-de-sacs and T or hammerhead turnarounds; and
- r) if available at the time of Tentative Plan submission for approval, an acceptable storm drainage study and design prepared and stamped by a registered Professional Engineer.

4.3 Street Layout Standards

4.3.1 General

The arrangement, character and location of all new streets shall conform to acceptable planning principles and shall be considered in relation to existing and future streets, topographical conditions, public safety and convenience, and the proposed uses of the land. Where reasonable, a proposed subdivision street should be an extension of an existing street, either in the same subdivision or in adjacent subdivisions. Streets that exceed the maximum street length may require a variance from the RSC. In no case shall a cul-de-sac exceed 365 meters unless otherwise approved by the District Transportation Engineer (see section 4.3.4)

The street system must be integrated with the existing network of streets such that there are at least two points of access to each street. The street layout should be designed to take advantage of existing contours in order to provide satisfactory street gradients and suitable building lots, and to use existing water drainage pipes or open drainage systems for storm water. Natural features such as wetlands, watercourses, trees and rock outcrops should be preserved if possible so that they may be incorporated into the layout to enhance the overall design of the development.

4.3.2 Access

Every lot, block and other parcel of land in a proposed subdivision shall abut a public street or road. The RSC may approve such other access as being advisable for the development of land. The RSC may establish standards for the construction/design of private streets or access roads.

Where entry to a proposed subdivision will be gained by means of an existing road or street or other access, by whomever owned, the person seeking approval of the plan of such subdivision shall make provision to bring the existing access to the same standard as is required for streets within the proposed subdivision.

An access permit shall be obtained from the Minister of Transportation and Infrastructure before a person constructs, uses or permits the use of any private road, entrance way, driveway or gate or any municipal road or street intended for or capable of providing access to any part of a highway that has not been designated to be a controlled access highway. No person shall construct, use or permit the use of any private road, entrance way, driveway or gate or any municipal road or street intended for or capable of providing access to any part of a highway designated to be a controlled access highway.

Where a subdivision borders on or contains a rail road right-of-way or controlled access right-of-way, the Minister of Transportation and Infrastructure may require, as part of the subdivision design, a street approximately parallel to such right-of-way on each side at such a distance suitable for the appropriate use of intervening land. Such distances shall also be determined with due regard for the requirement of approach grades and future grade separations.

4.3.3 Grid Pattern

A grid pattern consists of straight streets running at right angles to each other at regular intervals as shown in Figure 4.3.3A and 4.3.3B. The grid pattern may be modified by breaking some streets to avoid monotony and provide a sense of enclosure.

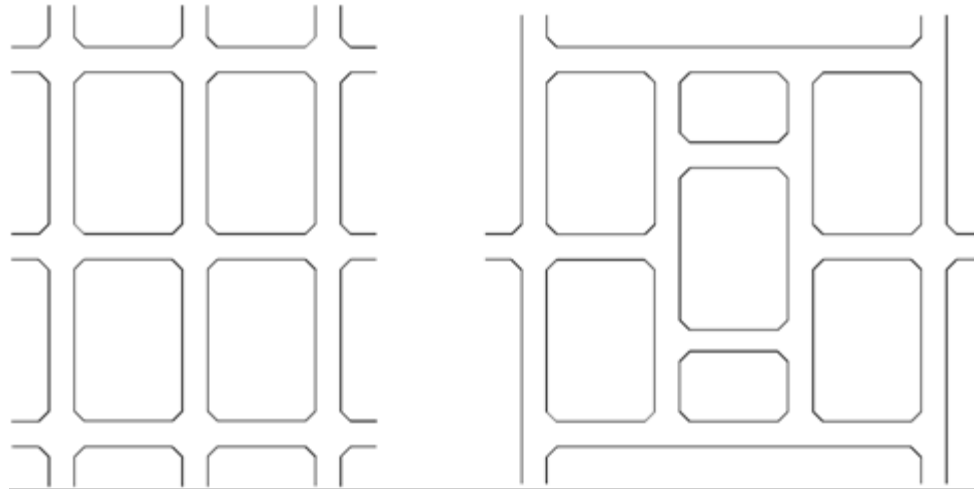

FIGURE 4.3.3A

FIGURE 4.3.3B

Care must be taken to determine if a grid plan is suitable for a new or rural community where the scale and type of housing is different from the development of the traditional urban grid plan. Using straight streets on hilly terrain may result in uncomfortable and undesirably steep grades for walking and driving. Traffic hazards are increased using a grid pattern since there is not a clearly defined traffic flow. Long straight streets are not visually pleasing, require careful house grouping and landscaping to provide some relief from the monotony of the plan, and do not provide a good traffic quieting strategy.

Where a grid or modified grid plan is considered to be appropriate, a block shall be between 120 and 240 metres in length and shall have a depth of at least two lots. As few houses as possible should face the shorter linking streets.

4.3.4 Cul-de-sacs

A cul-de-sac or "dead end" street is a short length of street with access only at one end. The street terminates with a temporary or permanent turning area to facilitate the turning of vehicles. Cul-de-sac arrangements do not provide a second access to a public highway and may be acceptable only if land topography and property dimensions offer no alternate method of development.

The maximum length of a cul-de-sac shall not exceed the fire-fighting capability of the fire department having jurisdiction (*National Fire Protection Code No. 5.2.17.2*). Another factor is due to the fire department's, or other emergency service providers' ability to quickly exit the cul-de-sac in response to the next emergency. Figure A1 (see Appendix A, page 43) illustrates a cul-de-sac having a maximum length of 365 meters for a public street to be created in New Brunswick.

A permanent cul-de-sac shall terminate with a circular turnaround area having a minimum radius of 25 metres to the edge of the right-of-way, as shown in Figure A2 (see Appendix A, page 44). The maximum grade of the turnaround area shall be 3% along the centerline of the travelled lane. The travelling surface of the turnaround area shall have a minimum radius of 18 metres. All layers shall be sloped to provide a 3% crown from the centerline toward its outside edge to ensure adequate drainage of the road.

A temporary cul-de-sac may end with a circular turnaround area as shown in Figure A3 (see Appendix A, page 45), or with a hammerhead or modified hammerhead meeting the requirements of either Figure A4 (Appendix A, page 46) or Figure A5 (Appendix A, page 47).

Temporary cul-de-sacs shall not be located in a way that interferes with the regular dimensions of a proposed lot. A cul-de-sac shall not intersect with a railroad line nor shall it contain a bridge structure at any point along its length. Permanent and temporary cul-de-sacs shall be paved over their entire surface, except in the situation shown in Figure A3 (Appendix A, page 45) which the portion of the paved surface must be pre-approved by the District Transportation Engineer.

4.3.5 P-Loops

A "P-Loop" is a looped street in the general shape of the letter "P" as shown in Figure 4.3.5 below.

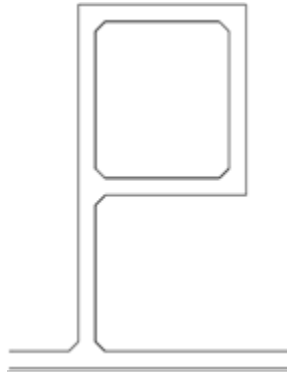

FIGURE 4.3.5: P-LOOP STREET

P-Loop arrangements do not provide a second access to a public street. They may be acceptable only if topography and property dimensions offer no other method of development. Future access to adjacent properties may be provided from the "P" portion of the design. As shown in Figure A6 (Appendix A, page 48), the length of the entrance leg must be between 120 and 180 metres. The inside of the P-Loop must contain a minimum of 4 lots. A P-Loop shall not intersect a railroad nor shall it contain a bridge structure at any point along its entrance length.

4.3.6 Intersecting Streets

4.3.6.1 General

Intersecting streets shall meet one another at an angle of 90 degrees where possible. In no case shall the angle of intersection be less than 70 degrees or greater than 110 degrees. As shown in Figure A7 (Appendix A, page 49), this alignment shall be maintained for a minimum distance of 50 metres measured from the centerline of the existing highway. For intersections within the proposed subdivision, the alignment shall be maintained for a minimum distance of 25 metres from centerline. Where a new street giving access to a subdivision enters an arterial or collector highway subject to a control line, the alignment of the new street shall be maintained at right angles where possible for a minimum distance of 25 metres from the point of intersection of the centerline of the new street with the control line of the existing highway as shown in Figure A8 (Appendix A, page 50).

4.3.6.2 Intersection Spacing

The minimum distance between a proposed intersection and an existing intersection, whether located on the same side or on the opposite sides of the existing highway, is dependent upon the posted speed limit of the existing highway plus 10 kph, and shall not be less than the spacing distances in accordance with Table A9 (Appendix A, page 51). Intersections shall be located in such a manner as to satisfy stopping and turning sight distance requirements detailed in Section 4.3.7 below.

Intersections of more than two cross streets and Y-intersections shall generally be avoided and will be considered only in exceptional circumstances.

4.3.7 Sight Distance Requirements

4.3.7.1 Street Intersections

All street intersections shall be located in such a manner as to satisfy stopping and turning sight distance requirements in both the horizontal and vertical planes. The stopping sight distance is to be measured using an eye height in the vertical plane of 1.05 metres and an object height of 0.38 metres. The required stopping sight distances shall be determined from Table A11.1, (Appendix A, page 53).

The turning sight distance is to be measured using an eye height in the vertical plane of 1.05 metres and an object height of 1.3 metres. The required turning sight distance shall be determined from Table A11.2, (Appendix A, page 53).

4.3.7.2 Driveway Accesses

All residential driveway accesses established on local and collector highways shall provide access to a maximum of 3 properties or residential units and must meet the criteria for stopping sight distance. Residential driveway accesses located on arterial highways must meet the criteria for stopping and turning sight distances. Stopping and turning sight distances are to be measured in accordance with Section 4.3.7.1.

Where a proposed street or road intersects with an existing public street or road, driveway access to corner lots shall be from the proposed street or road unless otherwise advisable due to sight distance restrictions. The driveway access will not be located within 15 metres of the right-of-way limits of the intersecting street, or prolongation thereof across the street.

All commercial, industrial and institutional driveway accesses on a local, collector or arterial highway shall meet the minimum requirements specified by Tables A11.1 and A11.2 (Appendix A, page 53).

A private driveway providing access to 4 or more properties or residential units is considered to be a private access and must meet the provisions of DTI's Access Point Policy (see Appendix 'A', Tables A11.1 and A11.2, page 53). The District Transportation Engineer may exempt an agricultural operation or woodlot owner from a sight distance requirement if the access is to be used on a seasonal basis and no other reasonable access location is available. No access of any kind shall be located near the crest of a hill or other location where a driver's vision is likely to be obstructed. All residential driveways shall have a minimum surface width of 6.0 metres. A commercial or industrial driveway shall have a maximum finished surface width of 12.0 metres.

4.3.7.3 Subdivision Street Intersection with Local, Collector or Arterial Highway

A proposed subdivision street, which intersects an existing local, collector, or arterial highway, shall have a minimum sight distance determined by Tables A11.1 and A11.2 (Appendix A, page 53). The stopping and turning sight distances are to be measured using the procedures outlined in Section 4.3.7.1.

A registered New Brunswick Land Surveyor or Professional Engineer, or a qualified person under their direct supervision, must provide a sight distance inspection report where the proposed access to the subdivision intersects a public road or street. The District Transportation Engineer may conduct field inspection audits on these reports as required.

4.3.8 Lots, Blocks and other Parcels

Every lot, block and other parcel of land in a proposed subdivision must abut a public street. The size of every lot or other parcel of land in a subdivision shall meet the requirements set out in Table 4.3.8 below:

Table 4.3.8 – Minimum Lot Sizes

Service	Minimum Width (m)	Minimum Depth (m)	Minimum Area (m ²)
Water & Sewer System	18	30	540
Sewer System Only	23	30	690
No Sewer System	54	38	4000

Lots fronting on more than one street should be avoided, except where they are required because of proximity to controlled access highways. In such cases, the lot should normally front on the minor road and, if possible, be screened from the controlled access highway. Generally, residential lots with double street frontage, except for corner lots, shall not be approved, especially if an alternate layout is available.

4.3.9 Street Names

Proposed street names must comply with NB 911 Civic Addressing Standards and be shown on the tentative plan and submitted to the Department of Public Safety (NB 911) for approval. The Developer is responsible for ensuring approval of all proposed street names prior to the tentative plan receiving approval. Once approved, street names should not be changed.

4.3.10 Future Streets

The Regional Service Commission recommends the location of Future Streets for adequate provision of access to future subdivision development phases or to avoid prejudicing development on adjacent properties. A street allowance or Future Street should be made at a maximum spacing of 240 metres, subject to RSC approval, to the boundary of the Developer's property in such a manner as to not prejudice future development of adjacent properties. Reserve strips abutting a street in a proposed subdivision are prohibited except where they are vested in the Crown.

The Minister of Transportation and Infrastructure shall not assent to a proposed subdivision until the Developer constructs any future street(s) shown on a previous or adjacent subdivision plan that provide(s) access to the proposed development. The Developer has the option of constructing the previous or adjacent future street(s) or posting a surety guaranteeing its/their construction in accordance with the Minimum Standards.

5.0 SUBDIVISION DESIGN AND DRAINAGE PHASE

5.1 Subdivision Design Approval

When the development officer has approved the tentative plan, the Developer may proceed with the preparation of design plans, drainage plans and drainage report. These documents shall be submitted to the Property Services Branch for review. Design and drainage documents must address all the conditions and information outlined in the tentative plan approval. DTI staff will review the information for acceptability based on the provisions contained in this Minimum Standards document, the Department's Standard Specifications, and Environmental Management Manual. Comments resulting from the review will be sent to the Consultant Engineer with a copy to the Developer. The Consultant Engineer shall address DTI's comments and make all necessary amendments to design and drainage. When DTI staff determines all design and drainage criteria are acceptable, the Developer will be formally notified that the plans are approved for construction.

5.2 Street Design

5.2.1 Horizontal and Vertical Alignment

All subdivision streets shall have a minimum horizontal curve radius of 90 metres and should be superelevated according to the values set out in Table 5.2.1 shown below. Two thirds of the superelevation should be developed at the beginning and run out at the end of the curve. The centerline distance between back to back reverse curves shall be a minimum of 15 metres.

Radius of Curve (m)	Superelevation (m/m)
7000	NC (Normal Crown)
900	NC
800	0.030
100	0.030
90 (min radius)	0.032

**TABLE 5.2.1 : SUPERELEVATION FOR HORIZONTAL CURVES
(POSTED SPEED = 50km/h)**

The vertical curve length of a subdivision street for both sag and crest curves shall not be less than the minimum values indicated in Figure A12 (Appendix A, page 54) for a 50 km/h design speed. Vertical crest curves shall have a minimum K-value of 6. Vertical sag curves shall have a minimum K-value of 11. If the Developer cannot achieve a recommended minimum K-value for a sag curve leading to an intersection, the Developer shall be responsible for the costs associated with the installation of street lights at the intersection.

5.2.2 Street Widths

Every subdivision street shall have a minimum right-of-way width of 24 metres. Depending on, but not limited to, the topography of the land and the soil type, additional right-of-way width may be required to accommodate foreslopes, ditches, and backslopes in heavier cuts and fills. The top of base shall have a minimum surface width of 10 metres. Design cross sections, at a regular spacing not to exceed 25 meters, shall be plotted at a 1:100 scale in both horizontal and vertical planes. Right of Way limits shall be shown on the cross sections reflecting any extra width required in areas of excessive cuts or fills. Right-of-way limits at street intersections shall be as shown in Figure A10 (Appendix A, page 52) unless otherwise approved by the Department of Transportation and Infrastructure.

5.2.3 Gradient

The street gradients in a proposed subdivision shall not exceed eight percent (8%). Street intersections require more stringent grade limitations because of their higher accident potential. As shown in Figure B3 (Appendix B, page 58), where two streets intersect, the grade on the minor road shall conform to the cross slope of the major road for a distance of 20 metres beyond the edge of the travelled surface of the major road. However, in no case shall the grade of the minor road exceed five percent (5%) within 20 metres of the edge of the travelled surface of the major road.

All proposed streets within the proposed development shall conform to Figure B1 (Appendix B, page 56). Unless required to slope to the invert of a cross culvert, open ditches shall not have a gradient in excess of eight percent (8%). The minimum ditch grade shall be one percent (1%). All embankment slopes shall have a 2:1 horizontal to vertical slope or flatter as shown in Figure B1 (Appendix B, page 56), unless otherwise directed by the District Transportation Engineer. Depth of slopes 3 meters or greater require installation of guide rail.

5.3 Drainage Study and Design

5.3.1 Drainage Study

The overall drainage pattern of a proposed development, including the location of municipal services easements for drainage purposes, shall be shown on design plans. The storm drainage study and design must be carried out by a registered Professional Engineer. Unless otherwise authorized in writing by the District Transportation Engineer for the most basic subdivisions and drainage patterns, no exceptions will be made.

The drainage study determines existing water drainage patterns in the proposed subdivision land and adjacent areas. The drainage design is used to evaluate the impact of pre-development versus post-development flows due to construction of a new subdivision or addition to an existing subdivision. When reviewing new subdivision drainage reports, the following items will be evaluated:

- Roadside ditches are designed to carry storm water away from the roadway, not as a conduit for rural drainage or as a way to attenuate post-development flows;
- Drainage entering or exiting a subdivision shall be confined to a Municipal Service Easement (MSE) and eventually directed to an existing mapped natural watercourse;
- There shall be no negative impact on all existing infrastructure or property;
- The drainage shall be designed to ensure no net increase from pre-development to post-development storm water discharge to receiving watercourses at peak conditions;
- Methods of attenuation, such as retention ponds, may be approved based on minimum design requirements used by the Department (see Appendix C, pages 61 to 66);
- Hydraulic capacity of culverts must accompany the drainage plan submission;
- If concentrated flows attenuated back to pre-development flow are deemed to have any potential risks to the maintenance of any ditches, roadway or infrastructure, greater attenuation may be necessary.

All design notes, calculations, and drawings used in the drainage study shall be stamped by a Professional Engineer and submitted to DTI for subdivision design and drainage review.

Plan view drawings shall show approved street names and indicate where flows enter, travel through, and exit the subdivision. All flow directions shall be identified on the plan views. Plan view drawings shall also indicate size and type of all culverts within the subdivision, including driveway culverts. The drainage basin and mapped watercourses shall be delineated on a 1:10,000 or greater scale orthophoto of the subdivision area or from other elevation data available (LiDAR or ground survey, e.g.) sufficient to generate contours at a maximum of one meter interval.

5.3.2 Municipal Services Easements for Drainage Purposes

All municipal services easements for drainage across lands adjoining those of the Developer shall be acquired by the Developer and conveyed to the Crown. All municipal services easements for drainage purposes shall have a minimum width of 10 metres.

When subdividing land, changes to existing drainage patterns should be minimized since severe disruption may cause erosion, siltation and damage to existing water supply systems and to adjoining land. No watercourse may be obstructed and no pond or swamp may be filled in such a manner as to alter the storm water run-off without the approval of the Department of Environment and Local Government and the District Transportation Engineer.

Where a watercourse traverses a subdivision, the Developer shall respect the 30m buffer unless stipulated in a WAWA Permit. When drainage enters a subdivision, the Developer shall provide a drainage feature within an MSE constructed to contain the flow and minimize erosion. When drainage is increased as a consequence of development, the net increased flow shall be attenuated to reflect pre-development rates.

The location of the municipal service easement is subject to change once the Department evaluates the drainage analysis supplied by the Consultant Engineer. **Under no circumstances will a watercourse be diverted toward and/or run along a subdivision ditch.**

Drainage ditches must be properly graded and left in a condition acceptable to the District Transportation Engineer. The Developer shall construct all off-take drainage ditches and follow the guidelines of the Department of Transportation and Infrastructure's "Environmental Management Manual" during and after construction activities have been completed.

Generally, off-take ditches shall not be piped. The embankment slopes shall have a 2:1 horizontal to vertical slope or flatter, unless otherwise directed by the District Transportation Engineer. Off-take ditches shall slope away from the road at a minimum grade of one percent (1%).

5.3.3 Attenuation Ponds

Attenuation ponds should be used to attenuate post-development flows to pre-development rates when other methods of attenuation are prohibitive. In such cases, the attenuation pond(s) shall be designed by a Professional Engineer and shall be consistent with DTI's Minimum Requirements for the Design and Construction of Dry Attenuation/Retention Ponds within Rural Subdivisions. See Appendix C, page 61 for attenuation design criteria.

5.3.4 Storm Sewers

If the topography in a proposed subdivision will result in excessive gradients or potential for soil erosion, the installation of a storm sewer with curb and gutter may be required to mitigate the excessive flows or erosion. The storm sewer system shall be designed and certified by a Professional Engineer. In this case, the Developer will be required to apply for a Highway Usage Permit (HUP).

5.4 Culverts

5.4.1 General

The size of the culverts shall be dictated by the potential of the watershed rather than that of an isolated small development. All culverts shall be designed for a $Q_{100} + 20\%$ flow having a minimum inside diameter as indicated below and be installed in accordance with the pipe manufacturer's specifications.

Culverts shall be reinforced concrete pipe; aluminum-coated corrugated steel pipe with a wall thickness of 2.8 mm; or plastic pipe, either smooth-lined corrugated polyethylene (PE) conforming to CAN/CSA B182.6 and having a minimum stiffness of 320 kPa in accordance with ASTM D2412, or polyvinyl chloride (PVC) pipe, DR 28 minimum, conforming to CAN/CSA B182.1 and/or B182.2. A kneewall is required in order to weigh the inlet end down to prevent water from flowing underneath or around all pipes 1200mm in diameter or greater. Pipes with diameters between 900mm and 1200mm should be checked for buoyancy.

The District Engineer should be consulted to determine if the culverts require a kneewall. Please note that approvals by the Department of Environment and Local Government may also be required.

5.4.2 Subdivision Entrance Culverts

The Developer shall install entrance culverts (as detailed in culvert design, page 62) having a minimum inside diameter of 600 mm for roads/streets joining an existing designated highway with a new subdivision. See Figure B4 (Appendix B, page 59).

5.4.3 Street Cross Culverts

The Developer shall install street cross culverts (as detailed in culvert design, page 62) having a minimum inside diameter of 600 mm where required for the proper drainage of the proposed development. See Figure B4 (Appendix B, page 59).

5.4.4 Driveway Culverts

Installation of all driveway culverts to individual lots within a proposed subdivision shall be the responsibility of the lot owners. These must be installed in accordance with the pipe manufacturer's specifications and also in accordance with the Department of Transportation and Infrastructure's "Access Point Policy". See Figure B5 (Appendix B, page 60).

5.5 Serviced Subdivisions

Where the installation of domestic water or sanitary sewer system or both is proposed to service lots in the subdivision, the Minister of Transportation and Infrastructure shall not assent to the subdivision plan until the requirements of the Community Planning Act have been met. A serviced local residential street shall meet the requirements set out in Figure B2 (Appendix B, page 57). In this case, the Developer will be required to apply for a Highway Usage Permit (HUP).

5.6 Environmental Permitting

If any construction work is to occur within 30 metres of a watercourse or wetland, a Watercourse and Wetland Alteration (WAWA) permit will be required as per the Clean Water Act. The Developer is responsible for obtaining this permit from the Department of Environment and Local Government.

The Developer is also responsible for having qualified personnel on site during construction to oversee quality control measures ensuring that the conditions contained within the WAWA Permit are being adhered to at all times. If the work is affecting an area greater than two hectares of wetland, an Environmental Impact Assessment (EIA) may also need to be completed.

6.0 SUBDIVISION CONSTRUCTION PHASE

6.1 Construction Inspections and Approvals

When the tentative plan is approved by the Development Officer, and design/drainage plans have been approved by the Department of Transportation and Infrastructure, the Developer may proceed with construction of streets and related works. The construction site must pass all requirements of the Department of Environment and Local Government (DELG) and meet the requirements outlined in DTI's "Environmental Management Manual".

The Developer shall retain the services of a Consultant Engineer, who will act as the Developer's inspector responsible for carrying out regular supervision and quality control inspections throughout the construction phase, ensuring all work meets or exceeds DTI minimum standards. The Consultant Engineer will be required to provide stamped documentation guaranteeing compliance with DTI standards. The documentation shall be in the form prescribed by the District Transportation Engineer. Prior to beginning construction, the Developer shall contact the District Transportation Engineer and advise DTI of their proposed construction schedule. He/she shall submit the names and contact information of the Developer's Consultant Engineer. The Consultant Engineer is considered to have authority and accountability on behalf of the Developer.

The District Transportation Engineer shall perform periodic quality assurance inspections during construction. The Developer will be responsible for notifying the DTI inspector of the work progress so that inspections may be performed during critical phases of the construction. DTI reserves the right to audit the work at any time during or after the construction. Any deficiencies identified by quality assurance or quality control shall be corrected by the Developer. The District Transportation Engineer shall prepare the final inspection report and provide a copy to the Developer and Property Services Branch.

6.2 Construction Schedule

The normal construction period for subdivision streets and related works is from June 1 to November 30 of each year in order to allow for proper inspection and approval by the District Transportation Engineer. **Any construction proposed between December 1 and May 31 may only be permitted at the discretion of the District Transportation Engineer.**

6.3 Construction of Streets

6.3.1 Clearing

The full width of the right-of-way shall be cleared of all trees, logs, bushes, cuttings and other perishable materials, unless otherwise directed by the Department of Transportation and Infrastructure. Burying of bushes, trees, cuttings or other perishable materials in the roadbed is strictly prohibited. Clearing debris must be removed from site and disposed of in a satisfactory manner. Cutting and burning is generally not permitted unless otherwise approved by the Department of Environment and Local Government and the Department of Natural Resources. All salvaged merchantable timber shall be removed from the right-of-way before the completion and final inspection of the street.

6.3.2 Grubbing

All roots, stumps and other organic matter shall be grubbed for the full width of the right-of-way and disposed of in a satisfactory manner. In fill sections, roots and stumps within a 2 meter perimeter of the subgrade shall be removed and disposed of as directed by the District Transportation Engineer. No material removed during grubbing shall be buried in the roadbed.

6.3.3 Grading

Grading consists of the excavation and placement of material within the limits of the right-of-way, or satisfactory disposal of excavated materials outside the right-of-way and includes the preparation and construction of the roadbed, embankment slopes, side ditches, trenches, waterways, off-takes and approaches to intersecting highways and private entrances.

The width of excavation at subgrade and inclination of side slopes shall be as required by the District Transportation Engineer. All cuts and embankments shall be shaped to conform to lines and grades approved by the District Transportation Engineer. Shaping shall be carried out as the excavation or embankment progresses so as to ensure that surface drainage is maintained at all times. Subgrade drainage must be completed before beginning placement of any Borrow, Subbase or Base materials. Softness on the roadbed at any stage of the construction must be addressed and corrected by the Developer regardless of the nature of the softness.

Solid rock excavation shall be carried out in accordance with the standards set out in the Department of Transportation and Infrastructure's Standard Specifications. Excavated material or imported Borrow A/A1 quality, as approved by the District Transportation Engineer, shall be placed in layers of not exceeding 300 mm and compacted to a minimum of 95% of ASTM D-698 or D-4253 maximum dry density, as determined by one of the following ASTM tests: D-1556, D-2167, or D-2922. Compaction test reports shall be made available by the Consultant Engineer upon request by the District Transportation Engineer. Borrow A/A1 quality material is to be used for the top 400 mm of fill prior to subgrade, and when an undercut is required.

In ungrubbed areas, swamps and rough terrain, the initial layer of an embankment shall be placed as directed by the District Transportation Engineer. Large stones and unsuitable materials in the roadbed shall be disposed of so that the roadbed is left in an acceptable condition.

6.3.4 Aggregate Subbase

All streets require an aggregate subbase layer, minimum 300 mm thick, compacted to 95% of the maximum dry density (see section 6.3.3 Grading). It may be pit run gravel, crushed gravel, or quarried rock and must be clean, hard and uncoated particles. The use of sandstone is generally prohibited and must be pre-approved by the District Transportation Engineer. The material must not contain impurities such as lumps of clay that would cause the subbase to deteriorate. Aggregate subbase material is required to meet the standards of the DTI's Standard Specifications set out under Item 203, and must adhere to the grading limits and property requirements set out under Item 201 of said Specifications.

6.3.5 Aggregate Base

All streets require a minimum aggregate base layer 150 mm thick, composed of 31.5 mm crushed gravel or crushed quarried rock. The base must be compacted to 95% of the maximum dry density (see section 6.3.3 Grading).

The Developer is responsible for placing 150 mm of the aggregate base before approvals may be considered under Section 7 of these Standards. The Developer will place an additional 25 mm as an allowance for loss and/or fine grading just prior to applying the chip seal surface. The Developer shall be responsible for making any repairs to the 150 mm base caused by contamination or excessive rutting and for any repairs to the chipseal surface between the first and second applications. Alternately, the Developer may post a surety for the additional 25 mm of aggregate base material, and amounts to guarantee against contamination of the base layer or damage to the all-weather surface. All surety amounts will be determined by the District Transportation Engineer in accordance with his/her inspection of the construction.

The aggregate base must be placed to provide a minimum surface width of 10 metres. Aggregate base material is required to meet the standards of the Department of Transportation and Infrastructure's Standard Specifications set out under Item 203, and must adhere to the grading limits and property requirements set out under Item 201 of said Specifications.

6.3.6 Finished Grade

All streets shall be chipsealed to a minimum width of 7.3 metres. The chip sealing shall be performed to the specifications outlined by the District Transportation Engineer. Alternately, the Developer may choose to have the chipsealing carried out by the Department by posting a surety for that purpose. For chipsealed surfaces, a double seal treatment is done in the first year followed by a second seal treatment the next year. For rural subdivisions, chipsealing shall be the preferred choice of an all-weather surface applied to the aggregate base material, however, the Developer may opt for placing asphalt paving in accordance with specifications issued by the District Transportation Engineer.

6.3.7 Guide Rail and Posts

Guide rail and guide posts will be installed in the locations specified by the Department of Transportation and Infrastructure. Guide rails and posts should be included in the engineering design plans. Guide posts shall be sound, rot-free and made from maple, birch, or beech. Prior to pressure treating, the posts shall be incised on all four sides and dried to a saturation point of 25 to 30% at 25 mm depth. Upon request by the Department of Transportation and Infrastructure, the Developer must submit the following:

- The product name and the manufacturer's specification for the preservation of the guide posts.
- The manufacturer's certification that the material supplied meets or exceeds the specification required in the Contract Documents.

The guide posts and guide rails shall meet the material and installation requirements specified in the Department of Transportation and Infrastructure's Standard Specification. The Developer will be responsible for the cost of installation of guide rails and posts as required.

6.3.8 Tack Mulching or Hydro Seeding

The Developer shall provide for mulching and/or hydro seeding in accordance with NBDTI's Standard Specifications, Sections 614 to 616, and/or as directed by the District Transportation Engineer.

6.4 Changes to Approved Design or Drainage

Should it become necessary to depart from approved design or drainage drawings due to unforeseen circumstances after construction has commenced, the Developer or his/her consultant engineer shall notify the District Transportation Engineer in writing. Upon approval by the District Transportation Engineer in writing, the consultant shall revise the design or drainage plans, as the case may be, and submit them to the District Transportation Engineer and to Property Services Branch.

Note: All layers referred to in this Section shall be graded to a 3% cross-slope. The finished surface shall be graded in accordance with Section 5.2.1. along horizontal curves.

7.0 FINAL SUBDIVISION APPROVAL PHASE

7.1 Requirements for Approval

The Developer must meet the following requirements for approval of the subdivision:

- a) The Regional Service Commission has approved the Tentative Plan,
- b) All street names have been approved by the Department of Public Safety;
- c) All design and drainage plans have been approved by the Department of Transportation and Infrastructure,
- d) The Developer has completed construction of all drainage infrastructure,
- e) The streets have been constructed to the top of base, including any turn-around areas,
- f) The Consultant Engineer has provided signed and sealed documents certifying the streets have been constructed in accordance with approved drawings,
- g) The District Transportation Engineer has inspected and approved the work, and recommends that DTI is prepared to accept the new streets,
- h) The Developer has posted a surety with the Department of Transportation and Infrastructure for:
 - i). the costs associated with applying an all-weather surface (chip seal or asphalt) to the subdivision streets;
 - ii). the supply and installation of all traffic control and street name signs within the subdivision (all signs will be manufactured and placed by DTI);
 - iii). any amounts required to ensure that the construction site passes all requirements of the Department of Environment and Local Government and of DTI's Environmental Management Manual;
 - iv). Any amounts required to guarantee against the contamination of the base layer prior to applying the all-weather surface, and may include an additional 25 mm of base material;
 - v). any amounts required to guarantee against damage to the all-weather surface during subsequent construction;
 - vi). completing all outstanding construction requirements in accordance with the Minimum Standards and/or those of the District Transportation Engineer.
 - vii). Completion of tack mulching or hydro seeding for stabilization of all exposed soils.

7.2 Approval by the Minister of Transportation and Infrastructure

The Developer has one year from the day of Development Officer's approval or reapproval of the tentative plan to file the final plan in the Registry Office. A draft copy of the final plan must be submitted to the Development Officer and to Property Services Branch before all necessary signatures are obtained. The Regional Service Commission and the Department may consult regarding the format and requirements of the final subdivision plan. The Regional Service Commission shall relay any of these requirements to the Developer and the Land Surveyor in preparation of the final plan.

Upon approval of the draft plan, the Land Surveyor may then prepare the final plan, signing and sealing the plan, and certifying that all standards of the Association of New Brunswick Land Surveyors have been complied with. All required signatures must be obtained on the plan before it is submitted to the Regional Service Commission.

The Minister of Transportation and Infrastructure will not assent to the final plan until the above requirements have been met, all regulatory signatures have been acquired, and the Regional Service Commission recommends in writing that the Minister assent to the final plan. The Property Services Branch prepares a brief to the Minister of Transportation and Infrastructure outlining that all requirements have been met, ensures a surety for the remaining construction has been received, and recommends that the Minister assent to the plan.

After the Minister's assent, the plan is forwarded to the Regional Service Commission. The Development Officer stamps his/her final approval on all copies of the plan, and sends them to the Developer. The plan must be filed in the Registry Office within one year from the Development Officer's approval.

The registration process vests the Public Streets and Municipal Service Easements in the Crown. Public Utility Easements are vested in the utility companies shown on the plan, and Parcel Identification Numbers (PID's) are assigned to the lots. Once these are completed, the Developer may sell the lots. The registry office will forward a copy of the registered plan to Government Departments and utility companies whose signatures appear on the plan.

7.3 Final Approval of Subdivision

The Developer has the option of being directly responsible for applying the all-weather surface or having the streets chip sealed by the Department of Transportation and Infrastructure. The chip sealing will be performed when 70% of the lots in the subdivision are built-out or after a two year period (whichever occurs first). As a minimum, one winter will have passed before chip sealing is applied to the street(s).

The District Transportation Engineer will prepare an estimate for surety funds associated with completing all outstanding construction as outlined in Section 7.1 and will advise the Developer and Property Services Branch. The surety estimate will be accompanied by conditions for final approval such as completion of chip seal, signing, lighting, slope stabilization, etc. If the Developer chooses to have DTI complete the chip sealing, the surety funds will be used for that purpose. Any additional works for which sureties are kept remain the responsibility of the Developer to complete. If the Developer has not completed any outstanding construction required within three years of filing of the final legal plan, other surety funds allocated for that purpose will be forfeited to DTI.

The Developer shall send the surety document to the Property Services Branch. The Department will accept sureties only in the form of a bank draft or certified cheque, payable to the Minister of Finance. Property Services Branch will be responsible for administering the surety funds.

The Developer is responsible for the replacement of any contaminated aggregate base material prior to chip sealing the street(s), regardless of who applies the chip sealing. The Developer will also be required to maintain or improve all environmental protection requirements until the entire construction process is completed.

The District Transportation Engineer will advise the Developer when all construction has been completed and approved. If there remains a balance in the surety funds, Property Services Branch will release any outstanding amount to the Developer upon request by the District Transportation Engineer. Finally, the Department's records are updated to reflect the addition of the new streets to its highway network.

APPENDIX A

PLAN VIEWS

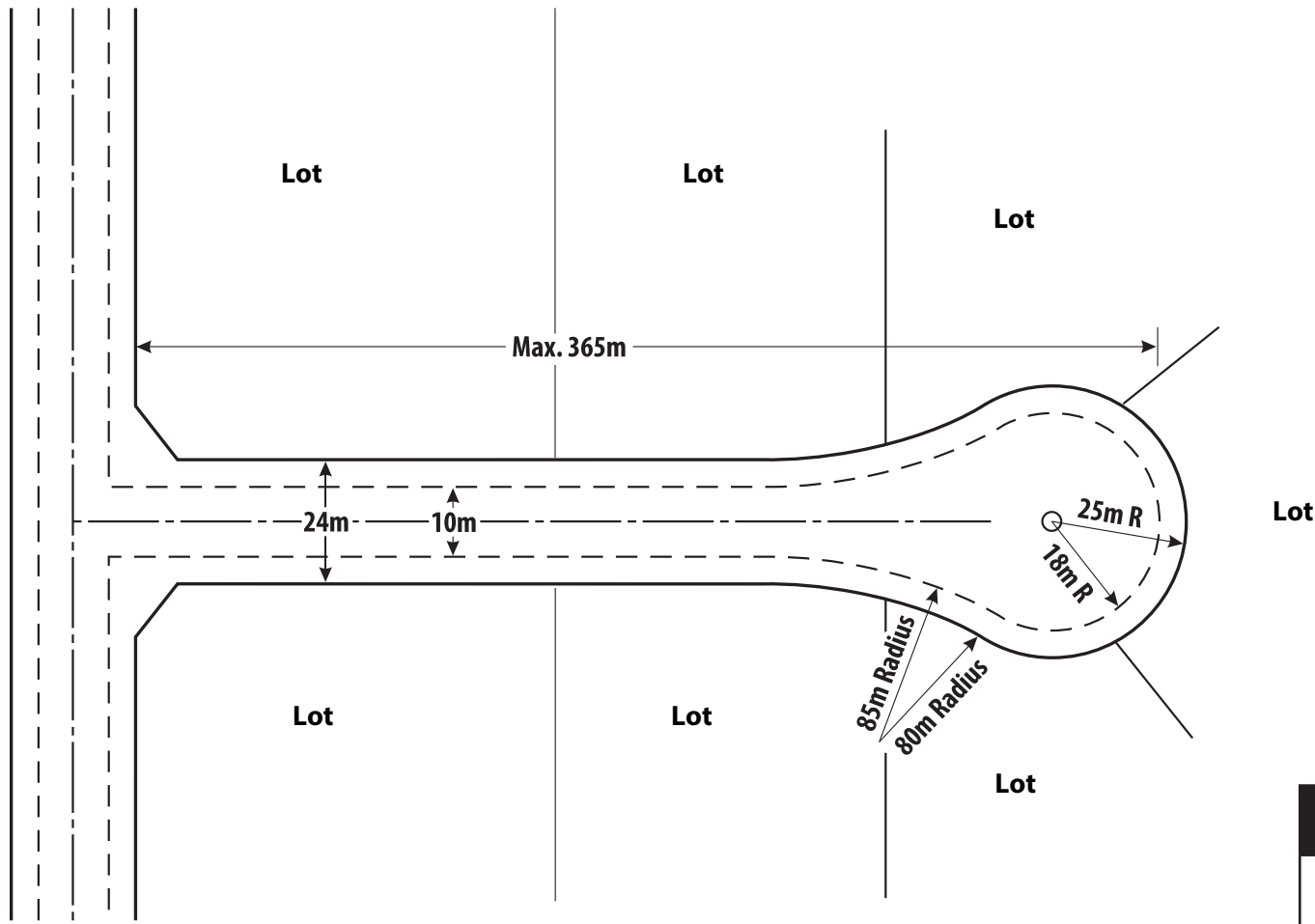

- Note:**
1. Check with the District Transportation Engineer in regard to municipal services easements, pipe sizes & construction materials.
 2. A future street providing access to adjacent properties shall not be used to extend maximum length of cul-de-sac.

Minimum Standards	
Department of Transportation and Infrastructure Property Services Branch	
Cul-De-Sac Layout	
Figure A1	
Not To Scale	Date: 2016

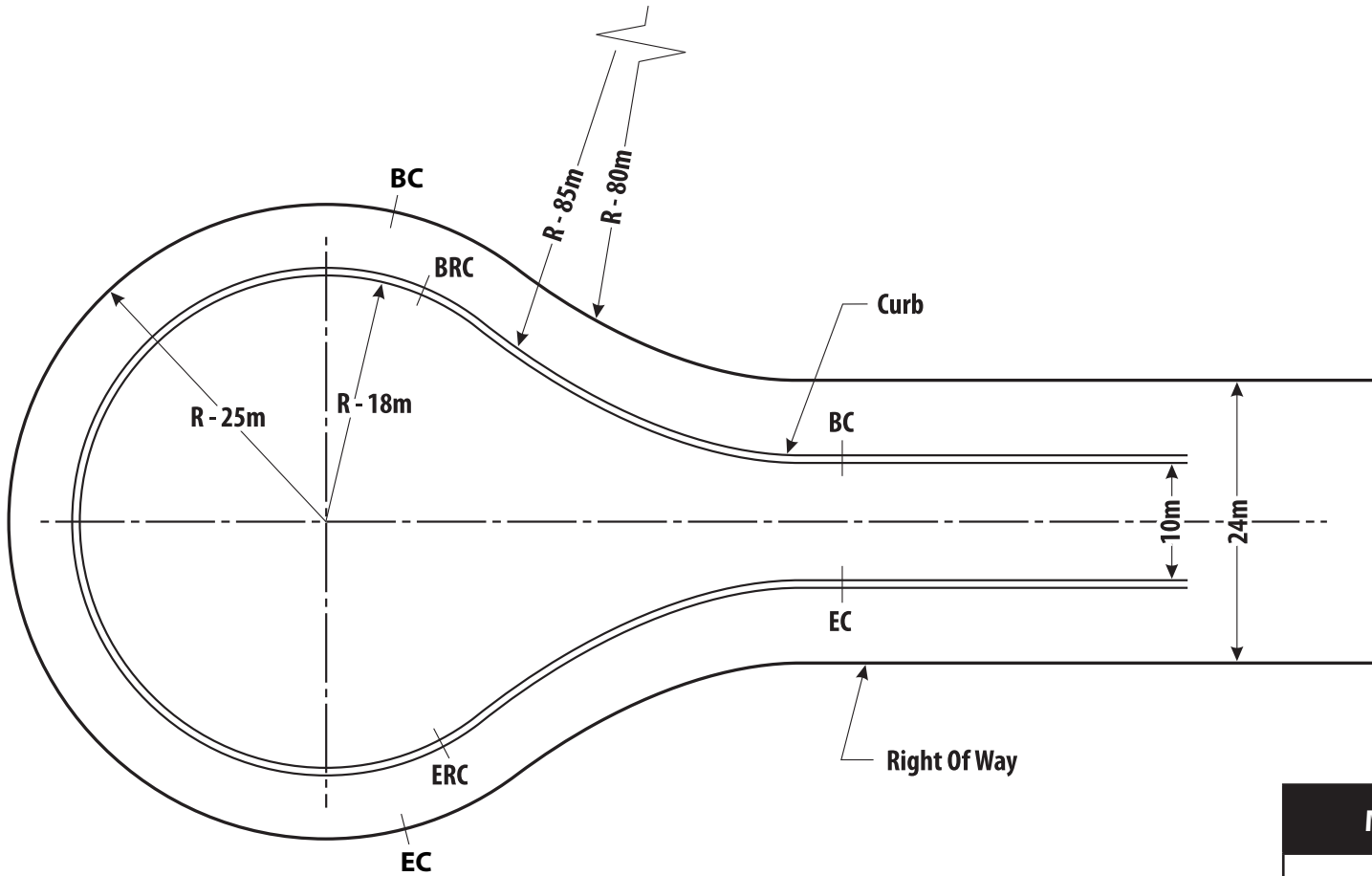

- Note:**
1. Typical turning circle at closed end of cul-de-sac showing minimum radii and start of extra right-of-way required for turnaround construction and maintenance.
 2. Permanent cul-de-sac length shall not exceed 365 meters from a public street right-of-way.

Minimum Standards	
Department of Transportation and Infrastructure Property Services Branch	
Cul-De-Sac Turning Circle	
Figure A2	
Not To Scale	Date: 2016

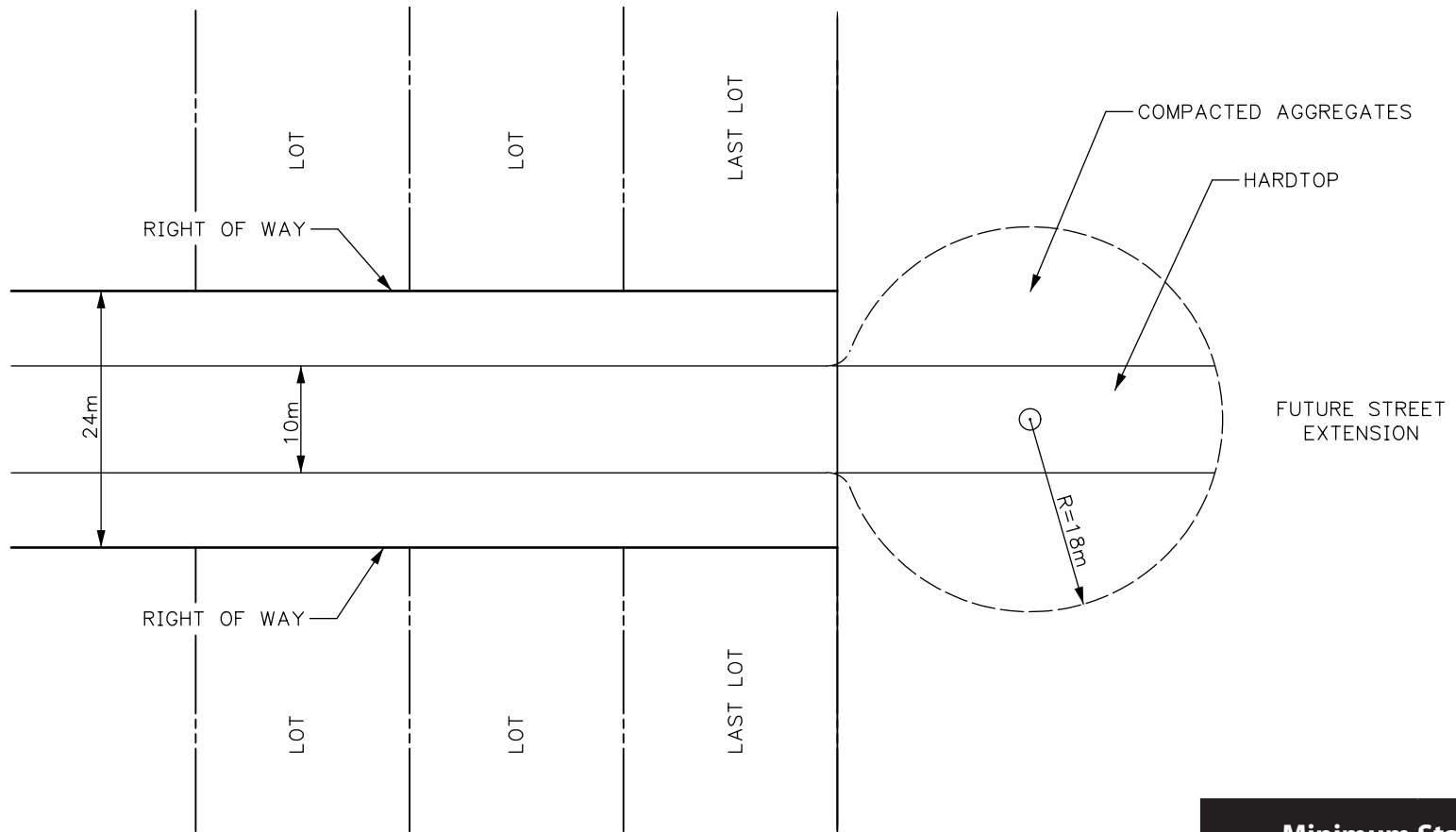

- Note:**
1. Temporary cul-de-sac shall be constructed immediately following the final lots of the current development.
 2. Length of temporary cul-de-sac in current development shall not exceed 365 meters from R.O.W. of existing public road.

Minimum Standards	
Department of Transportation and Infrastructure Property Services Branch	
Temporary Cul-de-Sac	
Figure A3	
Not To Scale	Date: 2016

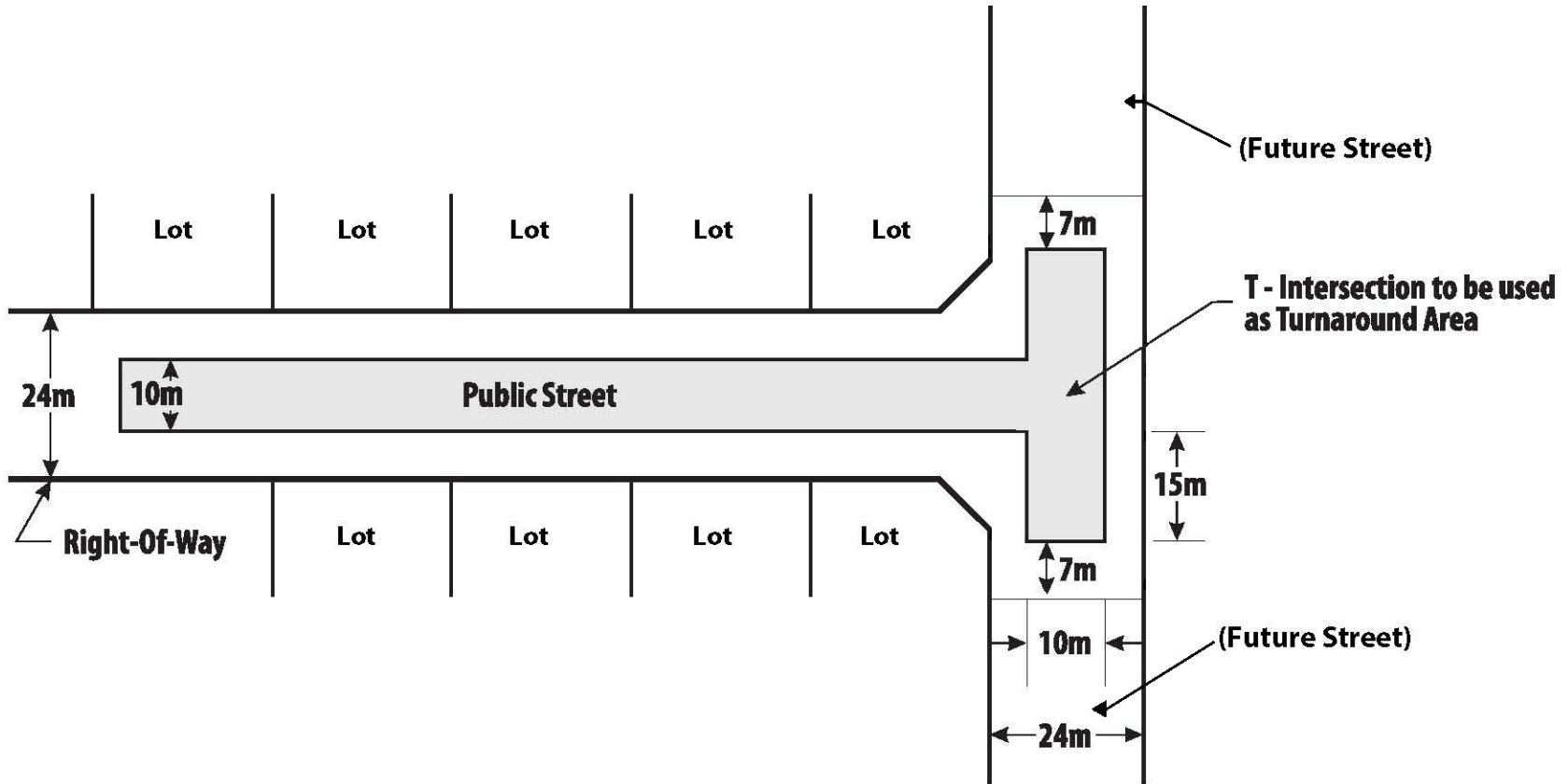

- Note:**
1. Area within heavy black line boundary vests in crown.
 2. Length of temporary cul-de-sac in current development shall not exceed 365 meters from R.O.W. of existing Public road.
 3. Shaded area to be constructed by Developer.

Minimum Standards	
Department of Transportation and Infrastructure Property Services Branch	
Turnaround Area for Hammerhead Cul-de-Sac Example 1	
Figure A4	
Not to Scale	Date: 2016

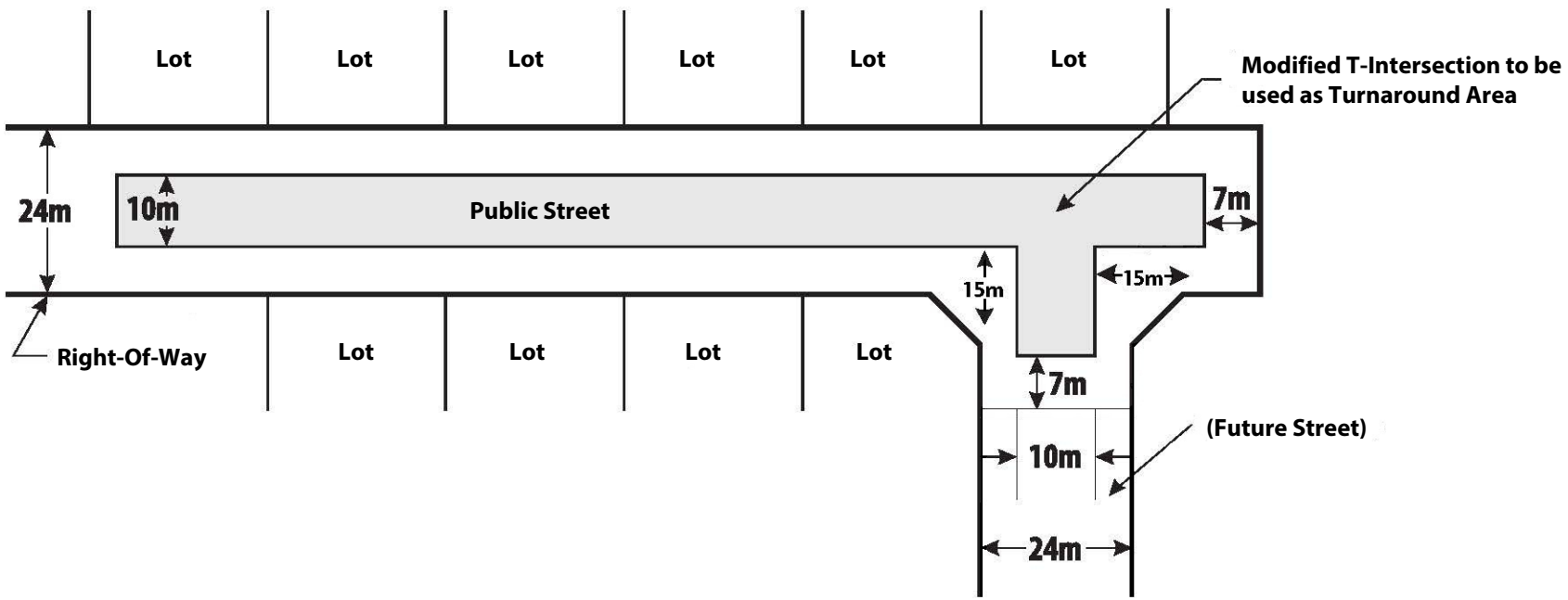

- Note:**
1. Area within heavy black line boundary vests in crown.
 2. Modified hammerhead temporary cul-de-sac shall be located adjacent to a lot.
 3. The hammerhead temporary cul-de-sac configuration may be on the left or right of the road.
 4. Length of temporary cul-de-sac in current development shall not exceed 365 meters from right-of-way of existing Public road.
 5. Shaded area to be constructed by Developer.

Minimum Standards

Department of Transportation
and Infrastructure
Property Services Branch

**Turnaround Area for Modified
Hammerhead Cul-de-Sac
Example 2**

Figure A5

Not to Scale

Date: 2016

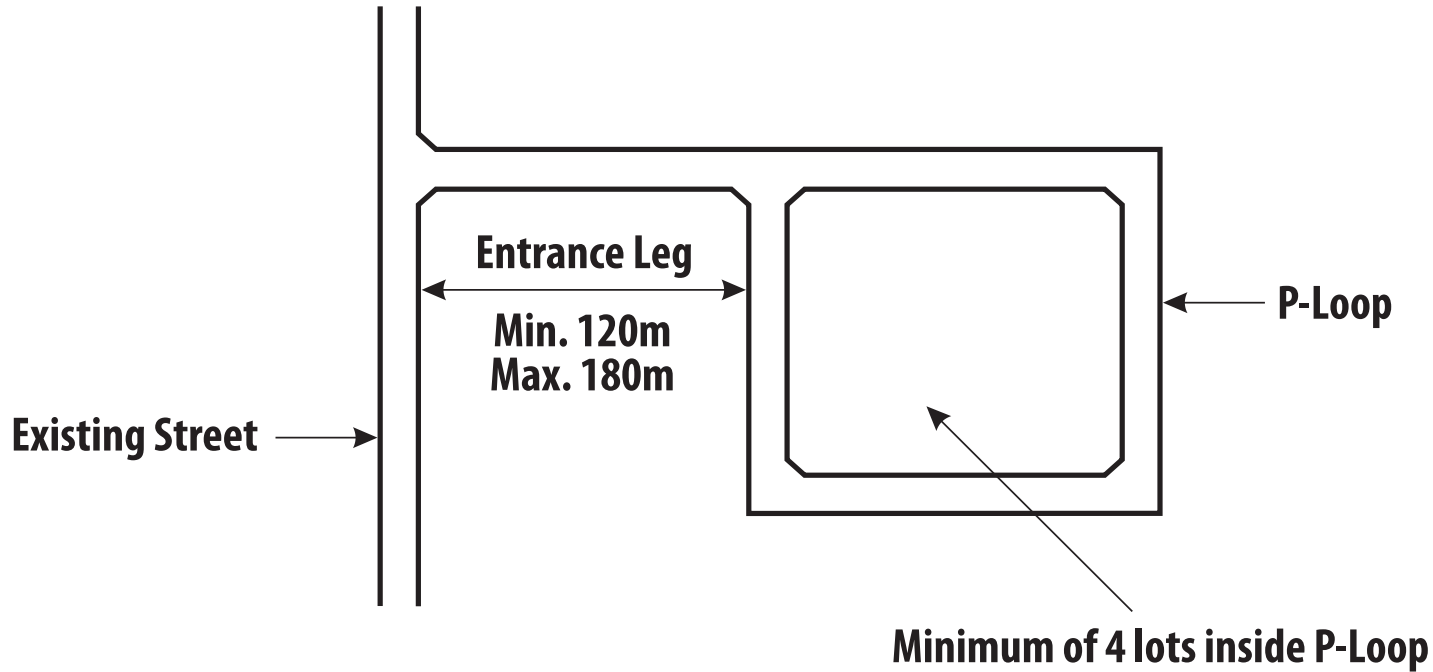

- Note:**
1. P-Loop Streets designed to be permanent will only be permitted if land topography & dimensions offer no other alternative method of development.
 2. Future streets may be required to provide access to adjoining land.
 3. Municipal services easements may be required, depending on the drainage pattern in the area.

Minimum Standards	
Department of Transportation and Infrastructure Property Services Branch	
P-Loop Standard	
Figure A6	
Not To Scale	Date: 2016

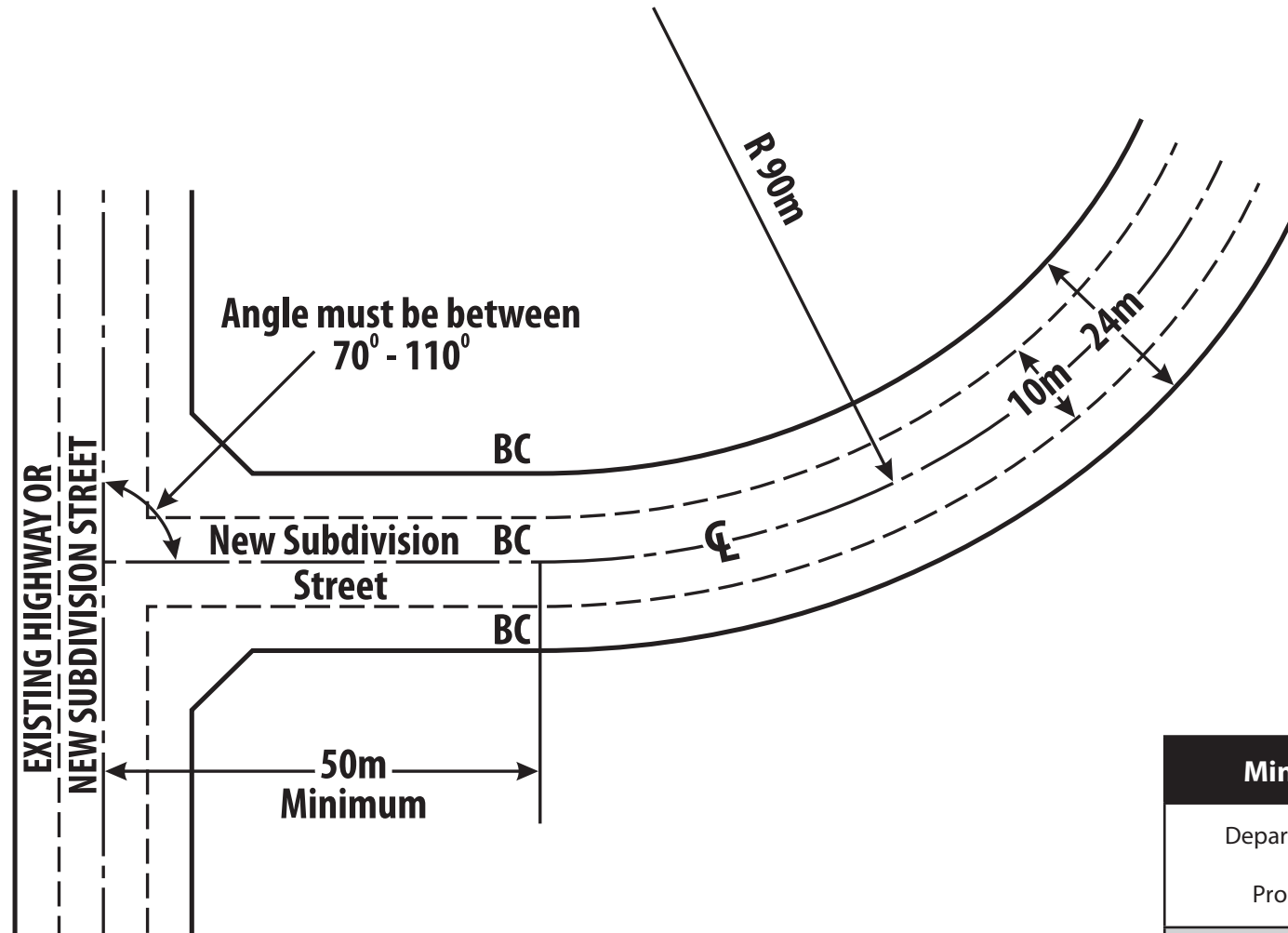

Minimum Standards	
Department of Transportation and Infrastructure Property Services Branch	
Intersection Alignment - No Control Line	
Figure A7	
Not To Scale	Date: 2016

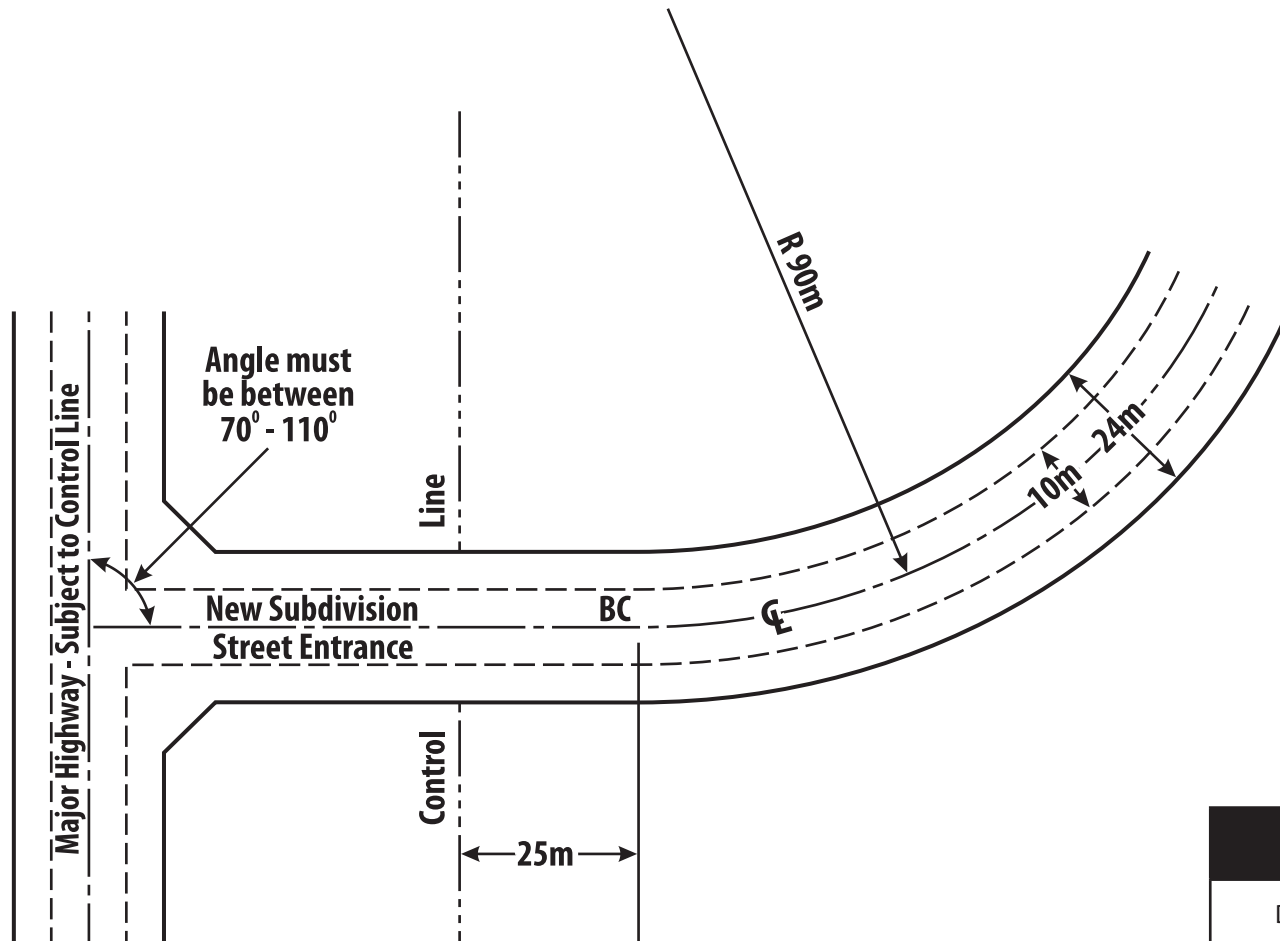

Minimum Standards

Department of Transportation
and Infrastructure
Property Services Branch

**Intersection Alignment for
Highway Subject to Control Line**

Figure A8

Not To Scale

Date: 2016

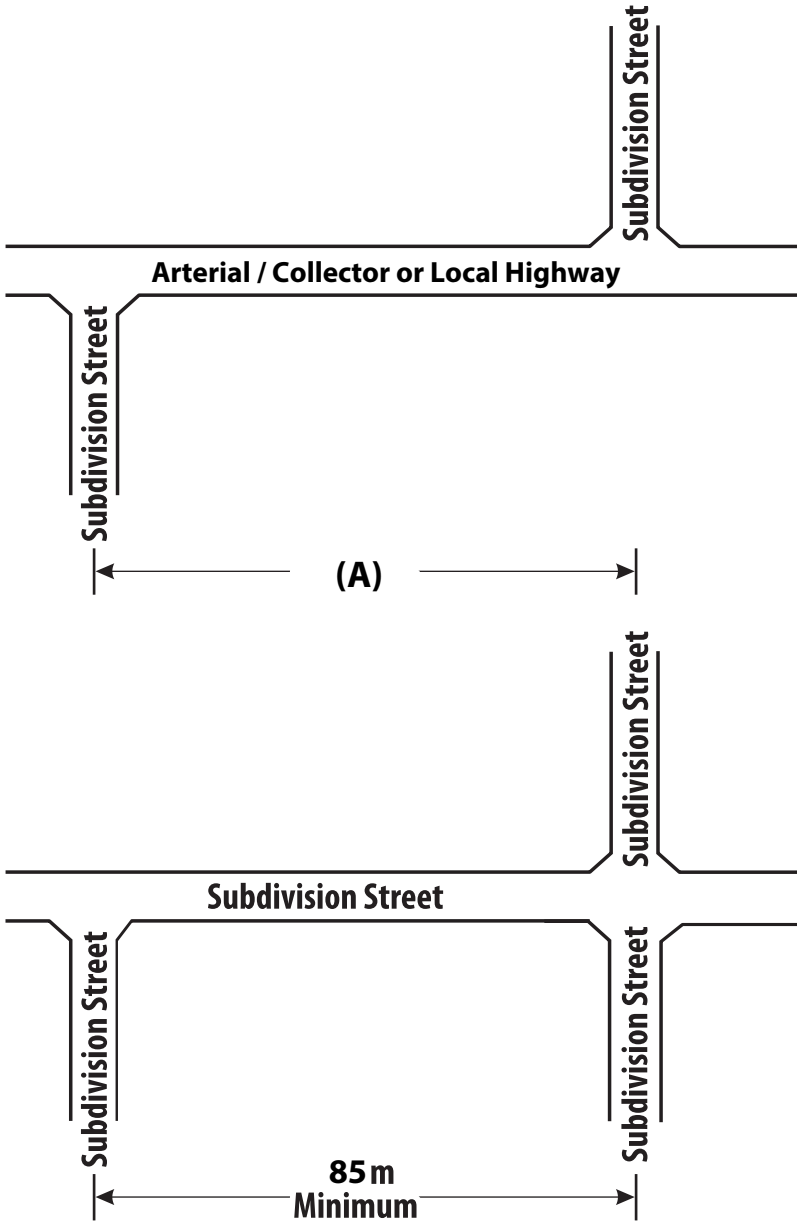

Table A9 – Road Intersection Distance

Posted Speed	Spacing between Intersections (A)
50	85
60	110
70	140
80	170
90	210
100	250

Minimum Standards

Department of Transportation and Infrastructure
Property Services Branch

Road Intersection Spacing (Including Table A9)

Figure A9

Not To Scale

Date: 2016

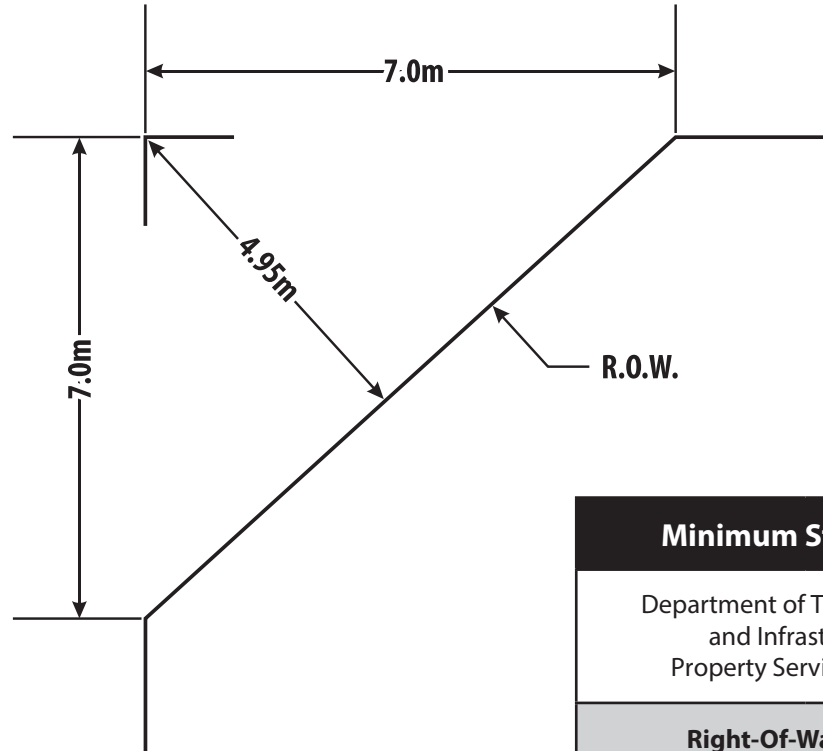
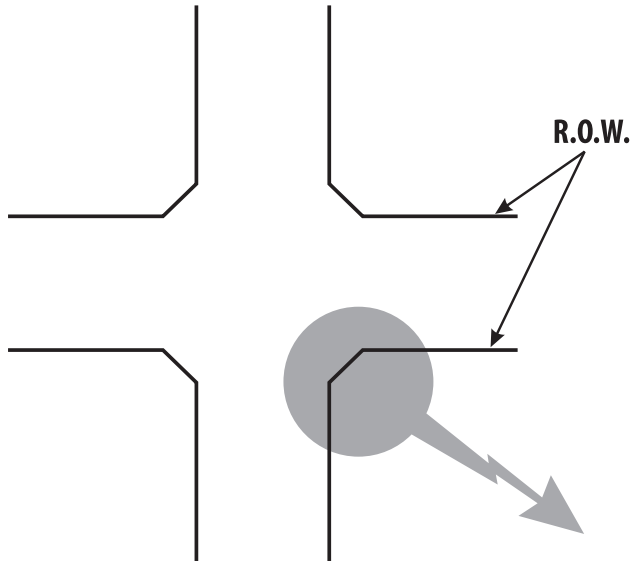

Minimum Standards	
Department of Transportation and Infrastructure Property Services Branch	
Right-Of-Way Limits at Intersections	
Figure A10	
Not To Scale	Date: 2016

MINIMUM SIGHT DISTANCES

TABLE A11.1 – Stopping Sight Distance	
* Speed Limit (km/h)	Sight Distance (m)
50	65
60	85
70	110
80	140
90	170
100	210
Object height = 0.38 m Eye height = 1.05 m	

TABLE A11.2 – Turning Sight Distance	
* Speed Limit (km/h)	Sight Distance (m)
50	115
60	135
70	160
80	180
90	200
100	215
Object height = 1.3 m Eye height = 1.05 m	

Table A11.1 must be satisfied for all accesses.

** Table A11.2 must be satisfied for all accesses excluding residential driveway accesses on Collector and Local Highways.

* In cases where prevailing vehicle speeds, if known, vary considerably from the posted speed limit, the higher of the two shall be used.

** Table A11.2 is not required for residential driveway accesses on Collector and Local Highways, in consideration of the lower anticipated traffic volumes; thus lower exposure to potential vehicular collisions, and the serious restriction on residential development of properties that would result.

Minimum Standards	
Department of Transportation and Infrastructure Property Services Branch	
Minimum Sight Distances	
Table A11.1 & Table A11.2	
Scale: Not To Scale	Date: 2016

Sag and Crest Curve minimum vertical curve length in metres for 50km/h

Approach Grade %	Exit Grade %								
	-8	-6	-4	-2	0	+2	+4	+6	+8
-8	0	50	50	66	88	110	132	154	176
-6	50	0	50	50	66	88	110	132	154
-4	50	50	0	50	50	66	88	110	132
-2	50	50	50	0	50	50	66	88	110
0	56	50	50	50	0	50	50	66	88
2	70	56	50	50	50	0	50	50	66
4	84	70	56	50	50	50	0	50	50
6	98	84	70	56	50	50	50	0	50
8	112	98	84	70	56	50	50	50	0

- Note:** 1. Minimal K Factor is 6 for Crest Curves and 11 for Sag Curves (for 50km/h)
 2. No Vertical Curve Length should be less than 50m

Minimum Standards

Department of Transportation
and Infrastructure
Property Services Branch

**Sag & Crest Curve
Minimum Vertical Curve Length**

Figure A12

Not To Scale

Date: 2016

APPENDIX B

PROFILES AND CROSS SECTION VIEWS

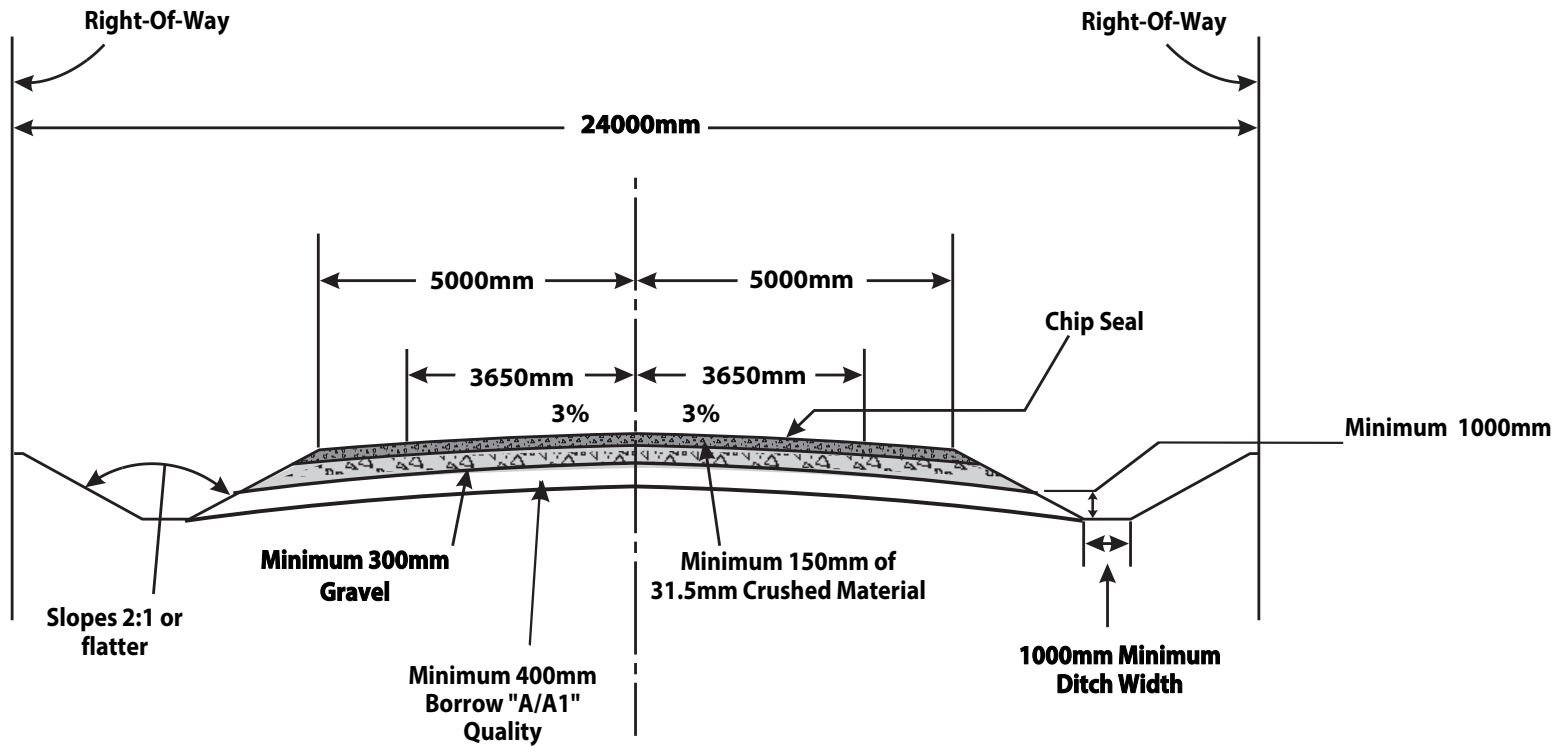
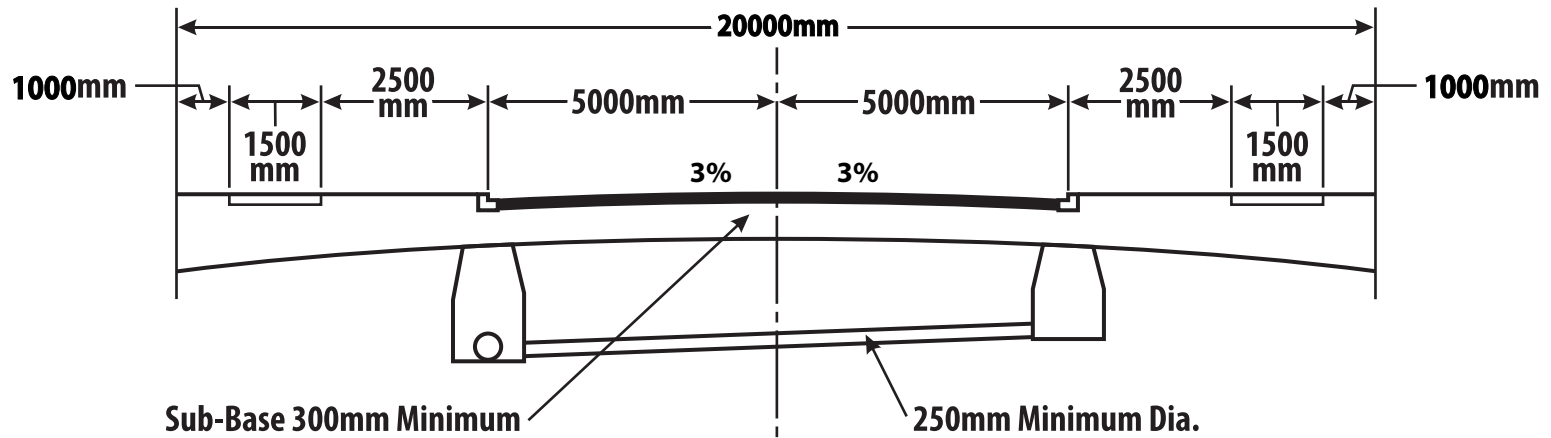

Figure B1: Typical cross section of Non-Curbed Local Highway, showing the minimum requirements for open drainage ditches.

Note: The required width of the street Right-Of-Way will depend upon the topography and soil conditions. The minimum street Right-Of-Way is 24000mm.

Minimum Standards	
Department of Transportation and Infrastructure Property Services Branch	
Non - Curbed Local Highway	
Figure B1	
Not To Scale	Date: 2016



Note: Check with the District Transportation Engineer in regard to municipal services easements, pipe sizes & construction materials.

Minimum Standards

Department of Transportation
and Infrastructure
Property Services Branch

Residential Streets Serviced Local

Figure B2

Not To Scale

Date: 2016

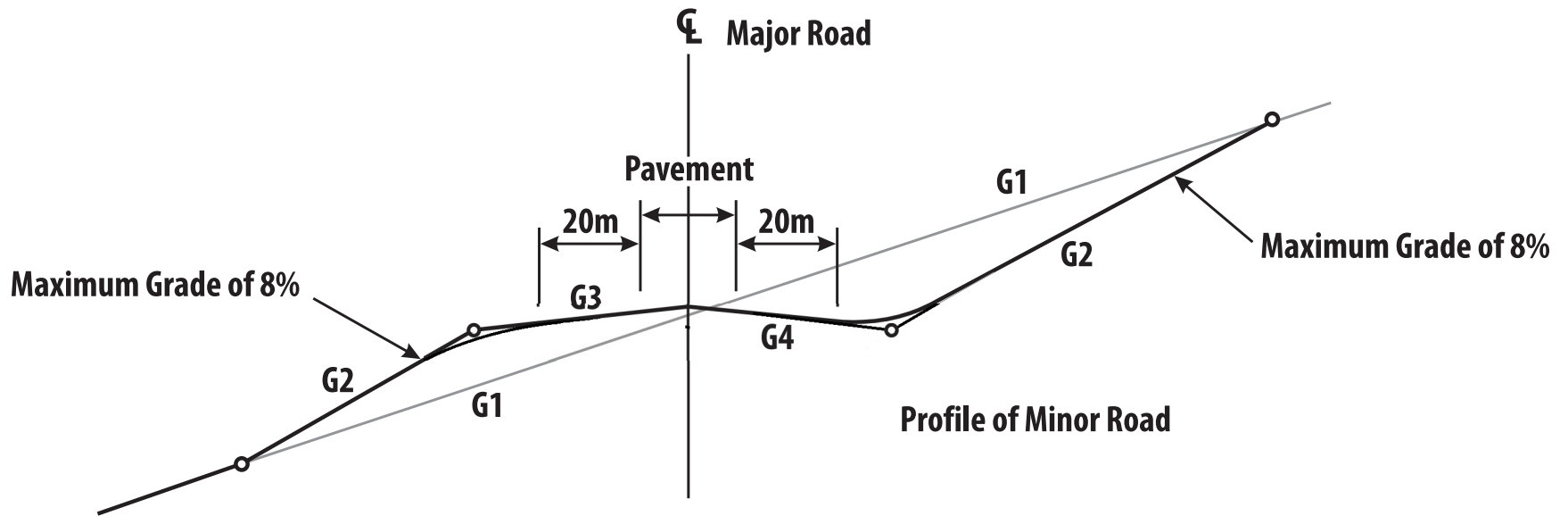

Note: **G1** Original Grade of Minor Road
G2 Grade introduced to reduce grade at intersection
G3 & G4 - Grade on Minor Road conforms to cross slope on Major Road (Grades 0.5% to 5.0%)

Minimum Standards	
Department of Transportation and Infrastructure Property Services Branch	
Profile of Minor Road	
Figure B3	
Not To Scale	Date: 2016

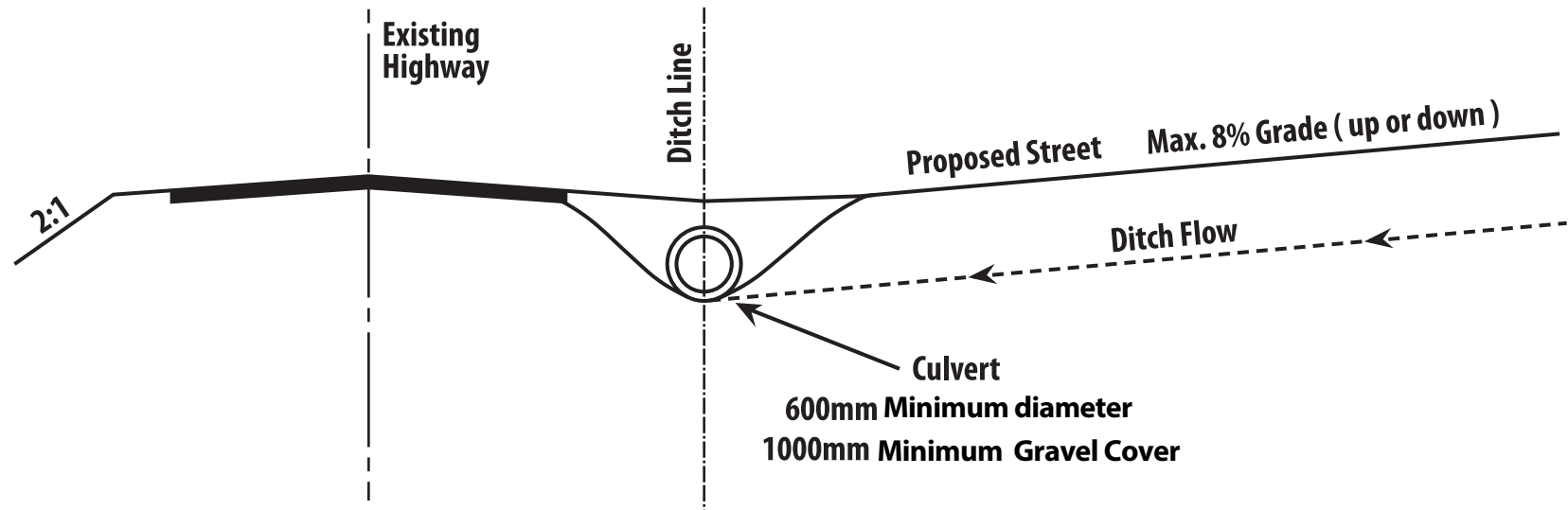

- Note:**
1. The entrance culverts to a subdivision are the Developer's responsibility.
 2. The size and length of the culvert pipe is to be determined by Departmental staff to conform to existing conditions.
 3. The proposed street shall be lower at the ditch line than the existing highway and graded to prevent water from flowing onto highway.
 4. Minimum and maximum culvert cover is as specified by the pipe manufacturer.

Minimum Standards

Department of Transportation
and Infrastructure
Property Services Branch

Entrance Culvert & Cross Culvert

Figure B4

Not To Scale

Date: 2016

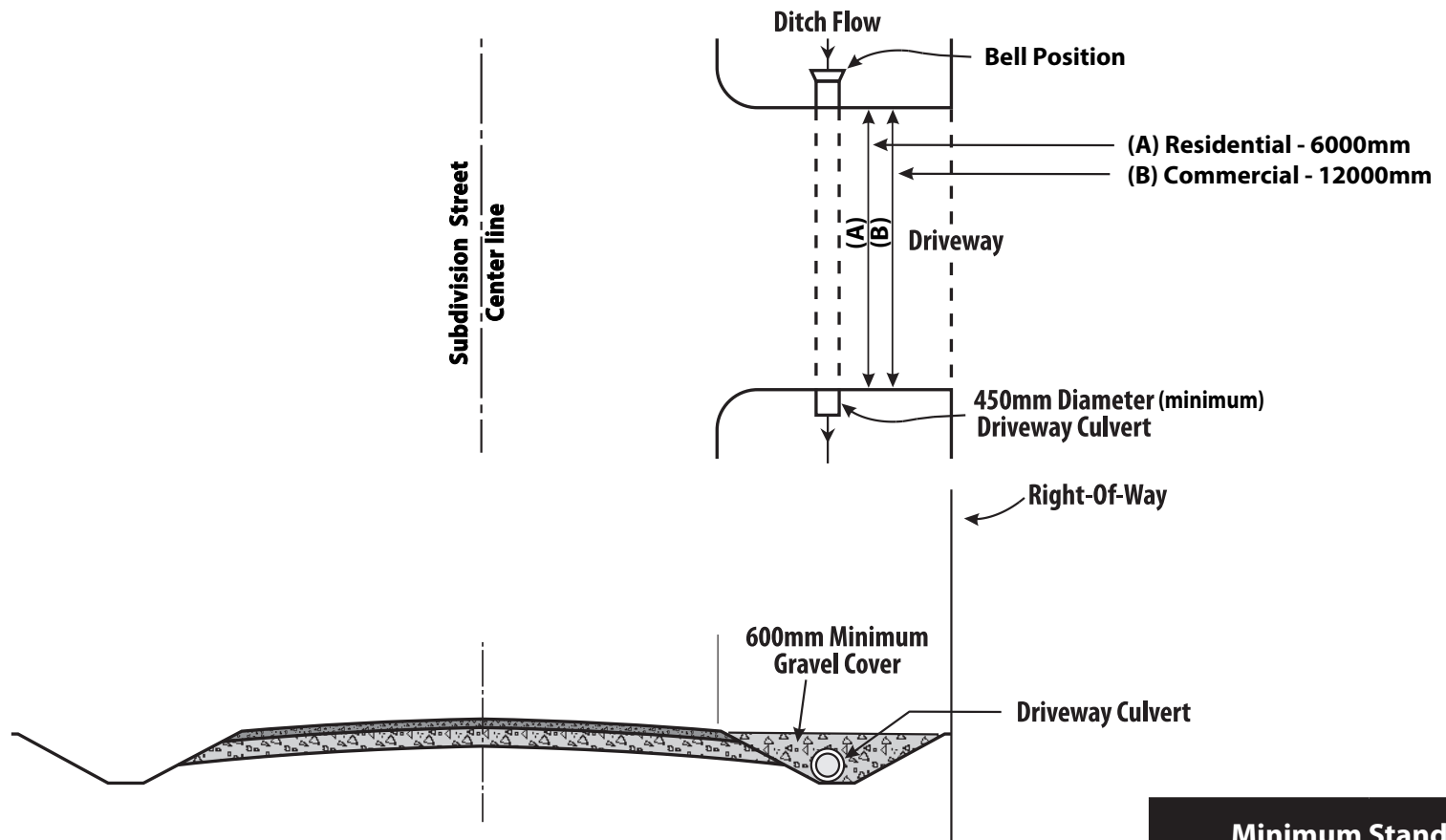

- Note:**
- Driveway culverts are to be installed by the lot owners.
 - Minimum pipe size - 450mm
 - Driveways are to be graded to prevent water from flowing onto the street.

Minimum Standards	
Department of Transportation and Infrastructure Property Services Branch	
Standard Driveway Culvert	
Figure B5	
Not To Scale	Date: 2016

APPENDIX C

DRAINAGE

Hydraulic Capacity of Culvert Design Used by the Department of Transportation and Infrastructure

- Delineate Drainage Area on a 1:10000 orthophoto.
- Design peak flow for a 1:100 year storm event ($Q_{100} + 20\%$ for climate change)
- Rational Method for Estimating Peak Discharges
 - $Q_{100} = 0.28 \times C \times I \times A$
 - C = Runoff coefficient (no dimensions)
 - I = Rainfall intensity in mm/h for a storm whose duration is equal to the time of concentration, T_c , for a specified return period
 - A = Drainage Basin Area in km^2

- Typical C values

Land Use	Run off Coefficient
Residential	0.5 – 0.7
Woodlands	0.25 – 0.3

These coefficients are for unfrozen ground.

- Intensity
 - $I = a \cdot T_c^b$

Note: the values of a and b can vary over time. Please use the most current values available at this link: http://climate.weather.gc.ca/prods_servs/engineering_e.html

- Bransby Williams Equation for rural Watersheds.
 - $T_c = (0.605 \cdot L) / (S^{0.2} \cdot A^{0.1})$
 - T_c = Time of concentration
 - L = Basin Length (km)
 - S = Slope (%)
 - A = Drainage Basin Area (km^2)
- Drainage area should include:
 - Elevation at top of Basin
 - Culvert Elevation
 - Length of Basin
- Nomograph used for culvert sizing (see Design Chart 2.31: Inlet Control, Circular Pipes, on the following page).

$HW \div D = 0.9$ (90% full capacity at $Q_{100} + 20\%$)
- Culvert type, size and class, identified on the plan
 - Mannings N value:
 - Concrete N = 0.012
 - Metal N = 0.024
 - HDPE N = 0.010

Other Considerations:

- Drawings shall show flow from subdivision to a mapped watercourse located on a 1:10,000 orthophoto.
- All drawings of subdivisions including plan views shall indicate where flow enters the subdivision, travels through the subdivision, and exits the subdivision. Identify flow direction in all ditches.
- All post-development flows from the subdivision shall not exceed pre-development flows to adjacent properties and to existing watercourses.
- All drawings of subdivisions including plan view will have street names labeled.
- Indicate size and type of all culverts, including driveways, within the subdivision on all drawings including plan view.
- Minimum and maximum pipe cover shall be verified with pipe manufacturer during design phase.
- NOTE: For developments in coastal areas, please refer to the document entitled, "*Updated Sea-Level Rise and Flooding Estimates for New Brunswick Coastal Sections*", published by the Province.

Design Chart 2.31: Inlet Control: Circular Pipes

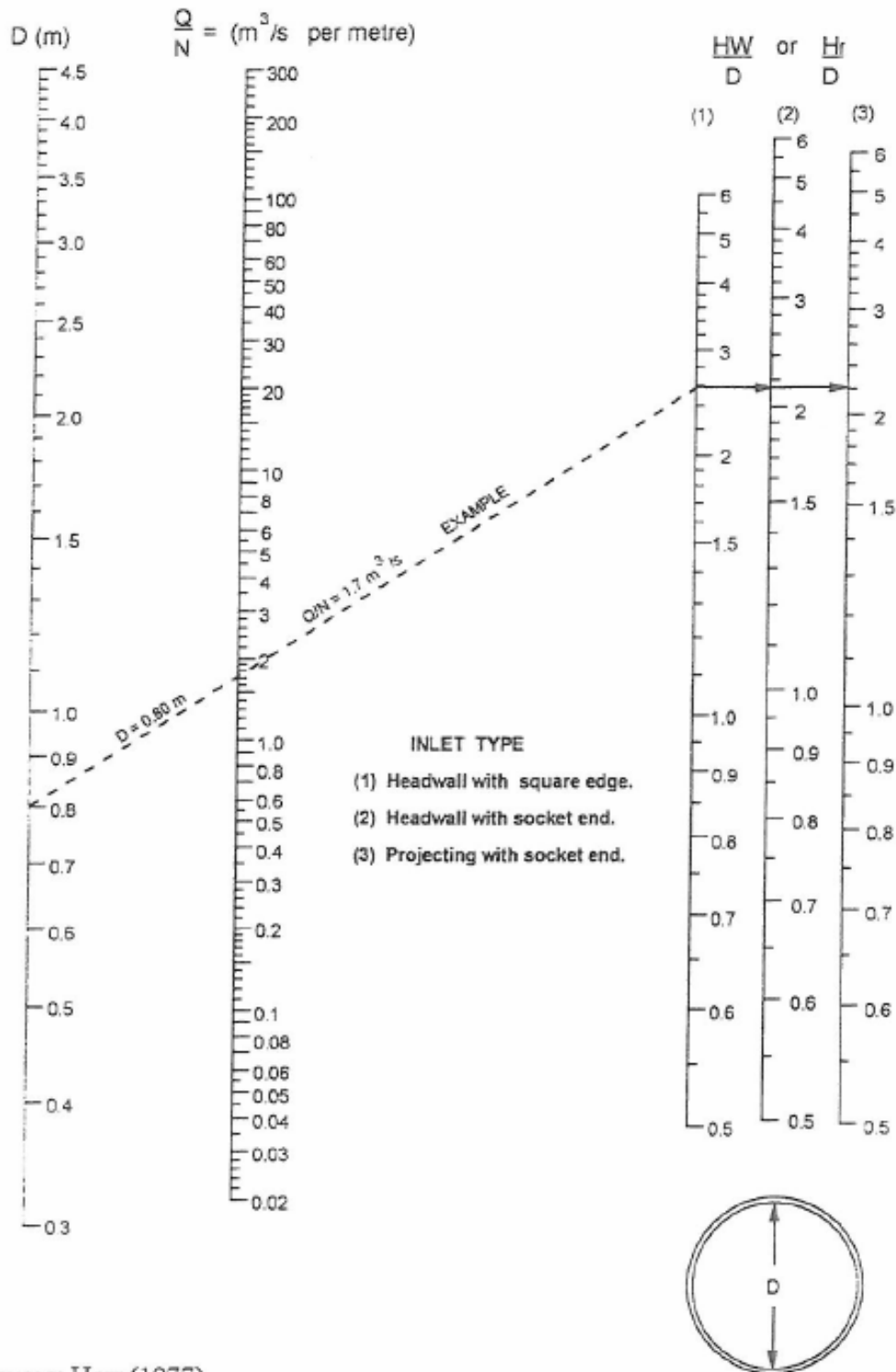

Source: Herr (1977)

Attenuation Pond Criteria for Rural Subdivision Development Drainage Design

- Storage capacity to attenuate peak flows to predevelopment levels.
- Maximum 0.9m deep (at maximum operating level, excludes Freeboard) should eliminate fencing, also no grass to keep maintenance costs down. If pond is greater than 0.9m in depth, then fencing is required.
- 300mm free board.
- Rock spillway sized for the $Q_{100+ 20\%}$ year flood and also rock downstream to prevent erosion. This should be based on velocity from $Q_{100+ 20\%}$.
- Grating or trash rack for the outlet pipe.
- Secondary pipe for backup, capped at outlet. This will be located at the same elevation as the primary pipe and will discharge onto Rip Rap.
- Rip Rap placed at the inlet to prevent erosion in the pond. This should be based on velocity from $Q_{100+ 20\%}$.
- Pond shall be lined with Rip Rap where required. Indicate size and location.
- Rip Rap placed at the discharge to prevent erosion.
- As-builts are completed with the designer's stamp (sign off) indicating construction is in accordance with the design.
- A minimum 5 meter wide easement will be required to perform maintenance.
- Maintenance and clean out before final Inspection.
- Access to the pond and berm shall be sized to accommodate vehicle for maintenance purposes.
- Surety of \$10,000 will be held for 2 years. Refundable if no maintenance by the Department is required.

Low Permeability Material for Dry Ponds

Low permeability material shall be used to construct the low Permeability Plug at the inlet of the discharge pipe for all dry pond design when in-situ material is not readily available or acceptable as a means of holding water to the operational level of the pond. This material shall contact the pipe on both sides, bottom and have the top at the dry pond operating elevation as shown on the drawing below. The low permeability material shall be a glacial till or clay. This material must be relatively free from organic material or other deleterious material to the satisfaction of DTI staff. Glacial till shall conform to the following grading limits:

Low Permeability Material Grading Limits

Sieve Size	% Passing
19mm	100
9.5mm	100
4.75mm	87-100
2.36mm	77-100
1.18mm	70-98
300µm	47-75
75µm	25-60

Limits of Excavation using Low Permeability Material

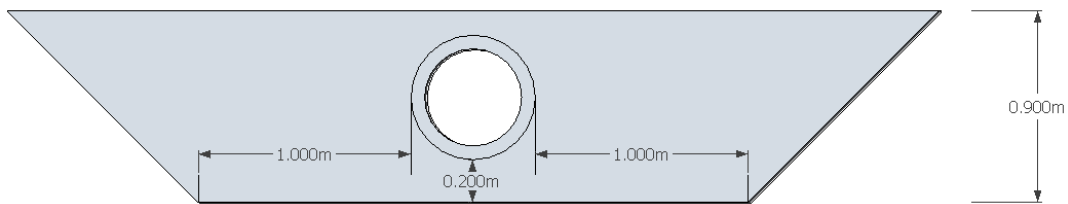

Longitudinal Section of Culvert with Low Permeability Material

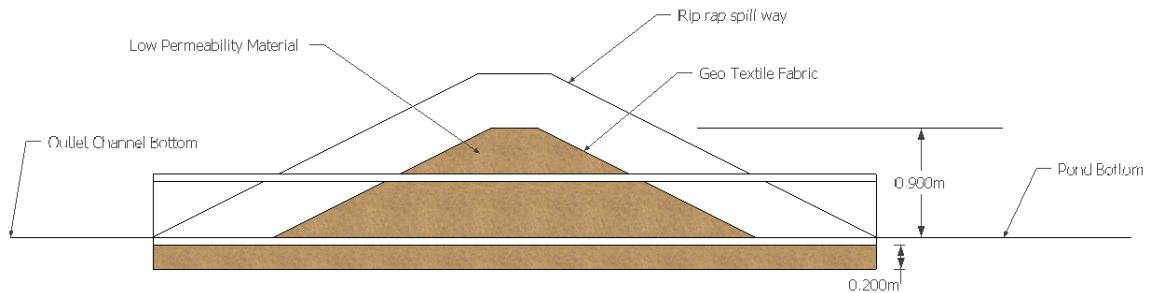

If the gradation limits are followed, this material should hold water to the operational level of the pond. This material also acts as a bedding for the pipe. The contractor should exercise caution when placing the rip rap over the pipe not to damage the culvert. A 2:1 slope allows the low permeability material to reach the 0.9m height. This could not be attained using a 3:1 slope. Filter fabric will not hold back water; it is there primarily to prevent the migration of fines. The intent of the dry pond is to keep post development flows to pre-development rates.

DTI will not accept dry pond designs without a detailed plan and profile of the pond, culvert and spillway. The plan/profile should clearly show but not limited to length, width, height, side slopes material and grade of the pond. The spill way should be shown in longitudinal section and a section view of the pipe inlet.

APPENDIX D

TRANSPORTATION DISTRICTS AND CONTACT INFORMATION

Map of Department of Transportation and Infrastructure's Districts

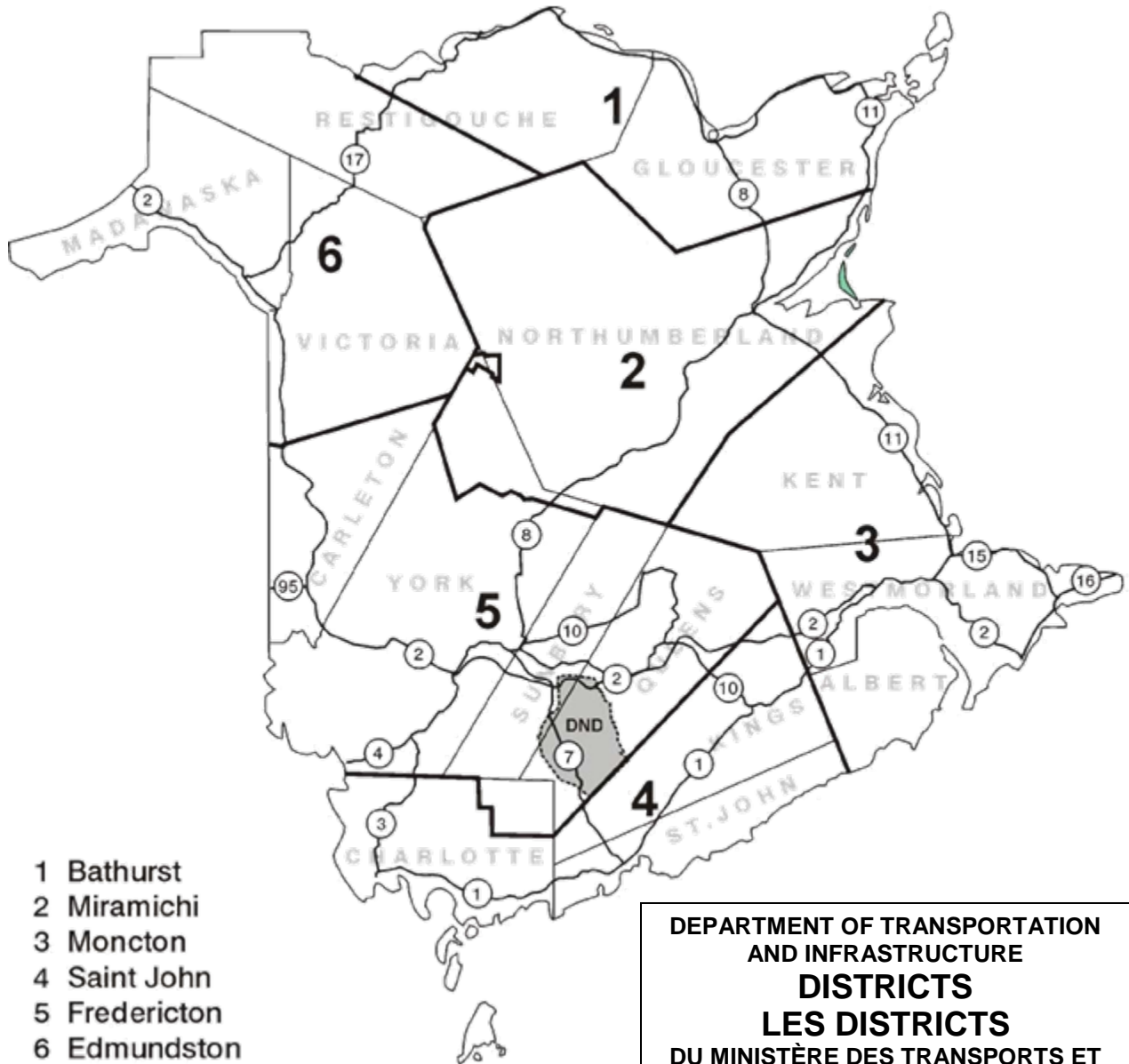

**DEPARTMENT OF TRANSPORTATION
AND INFRASTRUCTURE
DISTRICTS
LES DISTRICTS
DU MINISTÈRE DES TRANSPORTS ET
DE L'INFRASTRUCTURE**

Department of Transportation and Infrastructure District Contact Information

District No. 1
3109 Miramichi Avenue
PO Box 476
Bathurst, NB
E2A 3Z4
Telephone: 547-2144
Toll Free: 1-888-624-7077
Fax: 548-2838

District No. 4
50 Crown Street
Suite 105
Saint John, NB
E2L 2X6
Telephone: 643-7463
Toll Free: 1-888-915-1011
Fax: 643-7464

District No. 2
1310 Water Street
PO Box 248
Chatham Station
Miramichi, NB
E1N 3A6
Telephone: 778-6046
Toll Free: 1-888-787-3133
Fax: 773-6368

District No. 5
1025 College Hill Road
PO Box 6000
Fredericton, NB
E3B 5H1
Telephone: 453-2611
Toll Free: 1-888-922-9399
Fax: 453-7905

District No. 3
46 Toombs Street
PO Box 129
Moncton, NB
E1C 8R9
Telephone: 856-2000
Toll Free: 1-888-679-4044
Fax: 856-2019

District No. 6
486 St-Francois Street
PO Box 308
Edmundston, NB
E3V 3K9
Telephone: 735-2050
Toll Free: 1-888-767-9899
Fax: 735-2051