



New Brunswick Department of Environment and Local
Government

WATERCOURSE ALTERATION CERTIFICATION CERTIFIED INSTALLER MANUAL

Canada

New Brunswick
CANADA

New Brunswick
Your Environmental Trust Fund at Work
Votre Fonds en fiducie pour l'Environnement au travail



2022

1.0 INTRODUCTION

1.1	OBJECTIVE.....	1-1
1.2	DISCLAIMER.....	1-1
1.3	REGULATIONS.....	1-2
1.3.1	Permitting Agency.....	1-2
1.3.2	Legal Definitions.....	1-2
1.3.3	Working Definition of a Watercourse.....	1-3
1.3.4	Tips on Identifying Watercourses.....	1-4
1.3.5	Determining Channel Width.....	1-4
1.3.6	Presence of Fish Habitat.....	1-5
1.3.7	Regulating Precepts.....	1-6
1.3.8	Permitting System.....	1-8
1.3.9	Working on Crown Lands.....	1-8
1.4	COMPLETION OF TRAINING PROGRAM.....	1-9
1.4.1	Activities Permitted Under the Watercourse Alteration Certification Program.....	1-9
1.4.2	Activities Permitted by a Certified Installer.....	1-10
1.4.3	Responsibilities of Certified Installers.....	1-10
1.5	AUDITING WATERCOURSE AND WETLAND ALTERATIONS.....	1-10

2.0 WATERCOURSE AND WETLAND ALTERATION PERMITS FOR CERTIFIED INSTALLERS

2.1	WATERCOURSE ALTERATION CERTIFICATION PROGRAM.....	2-1
2.2	PERMIT APPLICATION PROCESS.....	2-1
2.3	REVIEW PROCESS.....	2-2
2.4	PERMIT EXCLUSIONS.....	2-5
2.5	WETLANDS.....	2-5

3.0 IMPACTS OF WATERCOURSE ALTERATIONS

3.1	BASIC PARAMETERS OF WATERCOURSES.....	3-1
3.2	EROSION.....	3-1
3.3	SEDIMENTATION.....	3-2
3.4	METHOD OF DEFENSE.....	3-2

4.0 SURVEYING FOR WATERCOURSE CROSSINGS

4.1	TERMINOLOGY.....	4-1
4.2	SURVEYING.....	4-3
4.3	EQUIPMENT.....	4-3
4.3.1	How to Set Up a Transit Level.....	4-3
4.3.2	Leveling and Using the Instrument.....	4-4
4.3.3	How to Read a Transit Level.....	4-4
4.3.4	Helpful Hints for Levels.....	4-4

4.3.5	Common Levelling Mistakes.....	4-5
4.3.6	Calculating Difference of Elevation.....	4-5
4.4	SETTING BENCHMARKS	4-6
4.5	SITE SURVEY	4-6
4.5.1	Begin Survey	4-6
4.5.2	Reducing Elevations.....	4-8
4.6	CREATE A WATERCOURSE PROFILE DIAGRAM.....	4-9

5.0 GENERAL REQUIREMENTS FOR ALL WATERCOURSE ALTERATIONS

5.1	WATER CONTROL MEASURES WHEN WORKING IN A WATERCOURSE	5-1
5.1.1	Sizing Requirement	5-1
5.1.2	Cofferdams.....	5-1
5.1.3	Dam and Pump Method.....	5-3
5.1.4	Temporary Diversions	5-4
5.2	EROSION PREVENTION AND SEDIMENTATION MANAGEMENT	5-5
5.2.1	Environmental Considerations.....	5-6
5.2.2	All Projects: Preventing Problems	5-6
5.2.3	Large Projects: Erosion and Sedimentation Prevention Plans	5-7
5.2.4	Planning Considerations.....	5-7
5.2.5	Road Crowning.....	5-8
5.2.6	Roadside Ditches	5-8
5.2.7	Check Dams.....	5-9
5.2.8	Straw/Hay Bale Barriers	5-10
5.2.9	Silt Fence Construction	5-11
5.2.10	Settling Pond (or Sediment Trap)	5-12
5.2.11	Off-Take Ditches	5-12
5.2.12	Cross-Drainage Culverts	5-13
5.2.13	Temporary Mulching.....	5-14
5.2.14	Permanent Re-Vegetation	5-15
5.3	MAINTENANCE OF MACHINERY AND PETROLEUM MANAGEMENT	5-15
5.3.1	Machinery and Equipment.....	5-15
5.3.2	Fuel Handling and Transfer	5-15
5.3.3	Clean-up Material	5-15
5.3.4	Storage.....	5-16
5.3.5	Reporting Procedures.....	5-16
5.3.6	Containment.....	5-17
5.3.7	Clean-up Procedures.....	5-17
5.4	MATERIALS USED IN AND NEAR WATERCOURSES AND WETLANDS.....	5-17
5.4.1	Fresh Concrete.....	5-17
5.4.2	Treated Wood.....	5-18

5.4.3	Rock material	5-18
5.5	SITE CLEAN-UP	5-19

6.0 CULVERT INSTALLATION

6.1	BASIC STANDARDS	6-2
6.2	TYPES OF CULVERTS	6-2
6.3	CULVERT SIZING	6-5
6.4	FISH PASSAGE	6-5
6.4.1	Watercourse Gradient/Slope and Fish Passage.....	6-5
6.4.2	Calculating Watercourse Gradient/Slope.....	6-7
6.5	MULTIPLE CULVERTS	6-10
6.6	TIMING OF INSTALLATION	6-10
6.7	CLOSED-BOTTOM CULVERT INSTALLATION	6-11
6.7.1	General Practices.....	6-11
6.7.2	Working in Isolation of the Stream Flow	6-12
6.7.3	Installation	6-12
6.7.4	Backfilling	6-14
6.7.5	Stabilization	6-15
6.7.6	Road Approaches.....	6-17
6.8	ENERGY DISSIPATION POOLS.....	6-18
6.8.1	Design	6-18
6.9	STREAM SIMULATION CULVERTS	6-19
6.9.1	Span the Stream	6-20
6.9.2	Set the Elevation Right.....	6-21
6.9.3	Slope Matches the Stream	6-21
6.9.4	Substrate in the Crossing	6-21
6.10	REPLACING CULVERTS.....	6-22

7.0 INSTALLATION OF AN OPEN-BOTTOM CULVERT AND BRIDGE CONSTRUCTION

7.1	OPEN-BOTTOM CULVERTS	7-2
7.1.1	Basic Standards	7-2
7.2	OPEN-BOTTOM CULVERT SIZING.....	7-2
7.3	OPEN-BOTTOM CULVERT INSTALLATION	7-3
7.3.1	Timing of Installation.....	7-3
7.3.2	Environmental Considerations.....	7-3
7.3.3	General Practices.....	7-4
7.3.4	Working in Isolation of the Stream Flow	7-5
7.3.5	Installation	7-5
7.3.6	Stabilization	7-6
7.3.7	Road Approaches.....	7-7
7.3.8	Replacing a Closed-Bottom Culvert with an Open-Bottom Culvert.....	7-7
7.4	BRIDGES VERSUS CLOSED-BOTTOM CULVERTS.....	7-9

7.4.1	Environmental Considerations.....	7-9
7.5	PERMANENT BRIDGES	7-9
7.5.1	Basic Standards	7-9
7.6	BRIDGE MATERIAL	7-10
7.7	BRIDGE SIZING	7-10
7.7.1	Bridge Length	7-10
7.8	BRIDGE CONSTRUCTION	7-11
7.8.1	Timing of Construction.....	7-11
7.8.2	General Practices.....	7-11
7.8.3	Working in Isolation of the Stream Flow	7-12
7.8.4	Constructing Bridge Abutments.....	7-12
7.8.5	Constructing a Bridge.....	7-13
7.8.6	Protecting the Bridge Abutments.....	7-13
7.8.7	Road Approaches.....	7-14
7.9	REPLACING BRIDGES	7-14
7.9.1	Replacing a Closed-Bottom Culvert with a Bridge.....	7-14
7.9.2	Replacing the Decking of a Bridge	7-15
7.10	TEMPORARY BRIDGES	7-15
7.10.1	General Practices	7-16
7.10.2	Temporary Bridge Construction	7-17

8.0 MAINTENANCE OF ROADS AND WATERCOURSE CROSSINGS

8.1	BASIC STANDARDS	8-2
8.2	WATERCOURSE CROSSING STRUCTURES	8-2
8.2.1	Culvert Maintenance.....	8-3
8.2.2	Bridge Maintenance	8-4
8.3	ROAD MAINTENANCE	8-4
8.3.1	Resurfacing the Roadway	8-5
8.3.2	Grading the Road	8-5
8.3.3	Brush Maintenance within Right-of-Ways.....	8-6
8.4	MAINTENANCE OF DRAINAGE CONTROL STRUCTURES	8-6
8.4.1	Roadside Ditches	8-6
8.4.2	Check Dams.....	8-7
8.4.3	Hay/Straw Bales and Silt Fences	8-7
8.4.4	Settling Ponds (or Sediment Traps)	8-7
8.4.5	Off-Take Ditches	8-8
8.4.6	Cross-Drainage Culverts	8-8
8.5	DECOMMISSIONING A ROAD	8-8
8.5.1	Water Bars	8-9
8.5.2	Removal of a Culvert.....	8-10
8.5.3	Removal of a Bridge.....	8-11
8.6	BEAVER ACTIVITY	8-12
8.6.1	Removal of Beaver(s).....	8-12
8.6.2	Removal of a Beaver Dam	8-12
8.6.3	Guidelines	8-13

8.6.4	General Practices	8-13
8.6.5	Chronic Beaver Activity	8-14

9.0 EROSION AND BANK PROTECTION

9.1	DEFINITION	9-2
9.2	OBJECTIVES	9-2
9.3	PLANNING CONSIDERATIONS	9-2
9.4	COMMON PRODUCTS USED FOR EROSION PREVENTION	9-3
9.4.1	Vegetation	9-3
9.4.2	Structural Products	9-3
9.4.3	Choosing an Erosion Protection Product	9-3
9.5	BIOTECHNICAL/VEGETATION	9-4
9.5.1	Definition	9-4
9.5.2	Objectives	9-4
9.5.3	Planning Considerations	9-5
9.5.4	Guidelines	9-5
9.6	RIP-RAP	9-6
9.6.1	Definition	9-6
9.6.2	Planning Considerations	9-7
9.6.3	Environmental Considerations	9-7
9.6.4	Construction	9-7
9.6.5	Guidelines	9-7
9.7	TIMING OF INSTALLATION	9-9

10.0 TIMBER HARVESTING

10.1	DEFINITIONS	10-2
10.2	OBJECTIVES	10-2
10.3	PLANNING CONSIDERATIONS	10-2
10.4	ENVIRONMENTAL CONSIDERATIONS	10-3
10.5	ACTIVITIES ASSOCIATED WITH TIMBER HARVESTING	10-3
10.6	HARVESTING	10-4
10.7	GUIDELINES	10-4

11.0 WATER INTAKE STRUCTURES

11.1	DEFINITION	11-2
11.2	OBJECTIVES	11-2
11.3	WATER WITHDRAWAL WITHIN CERTIFICATION	11-2
11.3.1	Dry Hydrants	11-2
11.4	PLANNING CONSIDERATIONS	11-3
11.4.1	Environmental Considerations	11-3
11.4.2	Water Requirements	11-3
11.5	GUIDELINES	11-4

12.0 GLOSSARY OF TERMS

13.0 REFERENCES OF DOCUMENTS

APPENDICES

APPENDIX A: WATERCOURSE ALTERATION CERTIFICATION
DATA SHEET..... ii
APPENDIX B: WETLAND IDENTIFICATION DATA SHEET..... vi
APPENDIX C: WATERCOURSE IDENTIFICATION DATA SHEET vii
APPENDIX D: DIRECTORY ix

1.0 INTRODUCTION

1.1 OBJECTIVE

One of the mandates of the New Brunswick Department of Environment and Local Government (DELG) is to promote environmental protection measures for activities potentially impacting watercourses and wetlands to sustain them and protect their aquatic habitats.

The purpose of this manual is to provide practical information focused on environmental protection throughout all stages of a watercourse alteration. These stages include, but are not limited to, planning, construction, installation, stabilization, and maintenance.

The goals of the Watercourse Alteration Certification Program are to:

- Improve the level of compliance with the [Watercourse and Wetland Alteration Regulation – Clean Water Act](#)
- Provide a better understanding of the importance of environmental protection and the requirements under the Federal [Fisheries Act](#)
- Improve the process for obtaining a watercourse and wetland alteration permit

1.2 DISCLAIMER

The manual and course materials outline the alterations types and their applicability that are permissible under the Watercourse Alteration Certification Program. Information is also provided to help navigate through the watercourse and wetland alteration permit application process.

The guidelines and technical information contained in this manual are intended to provide guiding principles for planning a watercourse or wetland alteration. None of the information contained should be considered as a code for the design or construction of any type of watercourse or wetland alteration.

It should be noted that other professionals may be required for the submission of a watercourse and wetland alteration permit. For certain alterations, a biologist capable of identifying wetlands may be required. In other cases, a professional engineer or environmental consultant may be required.

Responsibility for any action arising from any watercourse or wetland alteration must be borne by the Permittee and no liability shall be incurred by the Minister or the Department of Environment and Local Government. Any permit issued under the [Watercourse and Wetland Alteration Regulation](#) does not exempt or exclude the Permittee from the provisions of any Act of the Legislature of New Brunswick or of Canada to serve as legal defense to any action commenced by landowners who are adversely affected by the alteration.

1.3 REGULATIONS

The following sections explain the current regulating system, permitting agency, and approval process associated with watercourse and wetland alterations.

1.3.1 Permitting Agency

The New Brunswick Department of Environment and Local Government (DELG) is responsible for processing and issuing watercourse and wetland alteration permits as outlined in the [Watercourse and Wetland Alteration Regulation](#) (90-80) under the authority of New Brunswick's [Clean Water Act](#), C-6.1.

1.3.2 Legal Definitions

The following definitions are included in New Brunswick's [Clean Water Act](#), C-6.1, making them legally binding.

- A **watercourse** is the full width and length, including the bed, banks, sides and shoreline, or any part, of a river, creek, stream, spring, brook, lake, pond, reservoir, canal, ditch or other natural or artificial channel open to the atmosphere, the primary function of which is the conveyance or containment of water whether the flow be continuous or not.
- A **wetland** is land that, either periodically or permanently, has a water table at, near or above the land's surface or that is saturated with water and sustains aquatic processes as indicated by the presence of hydric soils, hydrophytic vegetation and biological activities adapted to wet conditions.
- An **alteration** is any temporary or permanent change made at, near, or to a watercourse or wetland or the water flow in a watercourse or wetland and includes:
 - any change made to existing structures in a watercourse or wetland including repairs, modifications or removal, whether the water flow in the watercourse or wetland is altered or not
 - the operation of machinery on the bed of a watercourse other than at a recognized fording place
 - the operation of machinery in or on a wetland
 - any deposit or removal of sand, gravel, rock, topsoil, organic matter, or other material into or from a watercourse or wetland or within 30 metres (100 ft) of a wetland or the bank of a watercourse
 - any disturbance of the ground within 30 metres (100 ft) of a wetland or the bank of a watercourse, except grazing by animals, the tilling, plowing, seeding and harrowing of land, the harvesting of vegetables, flowers, grains and ornamental shrubs and any other agricultural activity prescribed by regulation, that occurs more than 5 metres (16.4 ft) from a wetland or the bank of a watercourse
 - any removal of vegetation from the bed or bank of a watercourse
 - any removal of trees from within 30 metres (100 ft) of the bank of a watercourse
 - any removal of vegetation from a wetland or from within 30 metres (100 ft) of a wetland except the harvesting of vegetables, flowers, grains and ornamental

shrubs and any other agricultural activity prescribed by regulation, that occur more than 5 metres (16.4 ft) from a wetland

1.3.3 **Working Definition of a Watercourse**

The legal definition of a watercourse is very broad and all-encompassing, making it impractical from a permitting point of view. As such, DELG has adapted a working definition for a watercourse, which reads:

A feature for which its primary function is the conveyance or containment of water is described as being:

- a) the bed, banks and sides of any watercourse that is depicted on the New Brunswick Hydrographic Network (NBHN) (available on [GeoNB Map Viewer](#))
- b) the bed, banks and sides of any incised channel greater than 0.5 metre (1.6 ft) in width that displays a rock or soil (mineral or organic) bed, that is not depicted on the New Brunswick Hydrographic Network (NBHN) (available on [GeoNB Map Viewer](#)); water/flow does not have to be continuous and may be absent during any time of year, or
- c) a natural or human-made basin (*i.e.* lakes and ponds)

For permitting purposes:

- A permit is not required to modify an existing basin that is not depicted on the New Brunswick Hydrographic Network (NBHN), provided it is located 30 metres (100 ft) or more from a wetland or the shoulder of the bank of a watercourse, and it is not connected to or does not discharge directly to a watercourse or wetland. Examples include ponds created by mining operations, retention ponds, and artificially created impoundments.
- A permit is not required to construct an inline pond in a channel less than 0.5 metre (1.6 ft) in width.
- A permit is not required to create a pond at a seep or spring provided the near side of the pond is 30 metres (100 ft) or more from a wetland or the shoulder of the banks of a watercourse.

The working definition of a watercourse does not supersede the exemptions listed in the [Watercourse and Wetland Alteration Regulation](#). These exemptions are treated the same as always and a permit is not required for the following:

- Any alteration of or to those parts of a watercourse named in the first column of Schedule A that are on the seaward or downstream side of the line joining the associated location described in the second and third columns of Schedule A (as listed in the [Watercourse and Wetland Alteration Regulation](#))
- The maintenance of a roadway, railway or agricultural drainage ditch if (i) the ditch does not break the bank of a watercourse, (ii) no change is made to the alignment of

the ditch, (iii) there is no deposit of any material in a wetland, and (iv) there is no danger of pollution as a result of the maintenance.

1.3.4 Tips on Identifying Watercourses

The following can assist in identifying watercourses:

- If a watercourse is depicted on the New Brunswick Hydrographic Network (NBHN) (available on [GeoNB Map Viewer](#)), it is considered a watercourse by DELG.
- If aerial photos less than 40 years old show evidence of a watercourse, then it may be a watercourse. Evidence would include visible water, visible stream channel (riffles, eroded areas, bars, rapids, pools, etc.), and vegetation.
- Visit the site. Look for a clearly defined stream channel. If the channel is greater than 0.5 metre (1.6 ft) (bankfull width) and two or more of the characteristics described below are present, then it is a watercourse, unless otherwise determined by DELG.

Things to look for during a site visit:

- The channel has a mineral, organic, or soil channel.
- There is sand, gravel, and/or cobbles present in a continuous pattern over a continuous length, with little to no vegetation.
- There is an indication that water has flowed in a path or channel for a length of time and at a rate sufficient to erode a channel or pathway.
- There is presence of flowing water.
- The channel contains pools, riffles, rapids, and/or runs.
- There are aquatic animals, insects, fish, and/or aquatic plants.

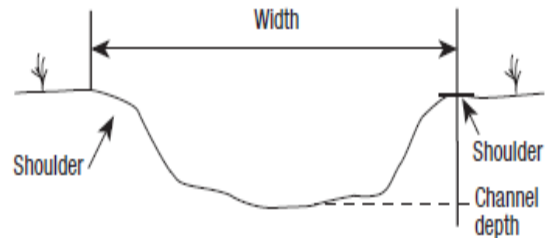

JUST A REMINDER

*Environmental protection measures apply to all watercourses regardless of size.
All watercourses are treated equally.*

See *Appendix C: Watercourse Identification Data Sheet* for an example of notes that can be taken during the field determination of identifying a watercourse.

1.3.5 Determining Channel Width

As a minimum, five measurements should be taken at least 5 metres (16.4 ft) apart upstream of the location of the proposed alteration, from the top of both stream banks (the shoulder of the banks), also known as bankfull width. See Figure 1-1.

Figure 1-1 Determining bankfull width

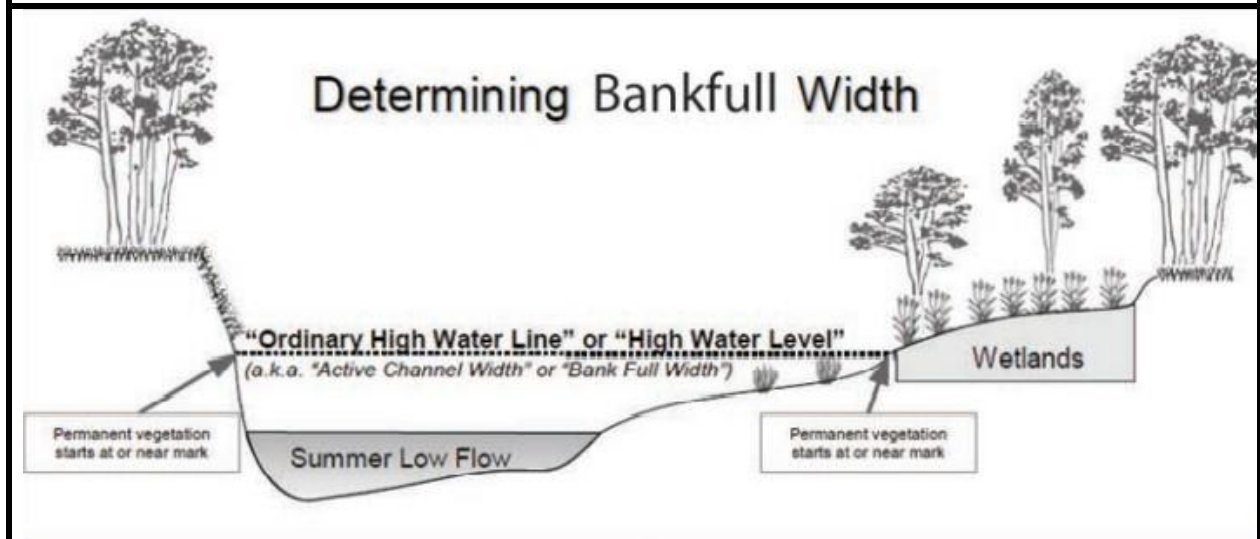

If this is not possible, then measurements should be taken immediately downstream of the proposed alteration site.

Be aware that a watercourse can disappear underground for a certain distance and reappear elsewhere. Some small streams may course through or connect to a wetland. You will need to walk some distance upstream and downstream to view conditions as part of your determination and not confine to evidence at a single location.

Keep in mind that watercourse channels can be modified during past developments. For example, lakes and ponds have been created or enhanced as artificial impoundments. If a watercourse was altered by ditching, dredging, or other types of development, such as a stream diversion or straightening of the channel, it is still a watercourse. If a channel was diverted and the original channel is dried up or was backfilled, the current diverted channel is now considered the watercourse.

1.3.6 Presence of Fish Habitat

The following is not considered as fish habitat:

- Artificial waterbodies that are not connected to a watercourse that contains fish at any time during any given year, such as:
 - private/artificial ponds
 - roadside drainage ditches
 - quarries and aggregate pits
 - irrigation ponds or channels
 - stormwater management ponds
 - agricultural drains and drainage ditches
 - commercial ponds like golf course ponds or stocked fishing ponds

- Any other waterbody that:
 - Does not contain fish at any time during any given year
 - Is not connected to a watercourse that contains fish at any time during any given year

It should be assumed that fish and fish habitat is present in all other circumstances.

1.3.7 **Regulating Precepts**

The watercourse and wetland alteration permitting system is regulated by the [Watercourse and Wetland Alteration Regulation](#) (90-80), under the authority of New Brunswick's [Clean Water Act](#). Watercourse and wetland alterations must also comply with the habitat provisions of the federal [Fisheries Act](#). Fish habitat is defined in the [Fisheries Act](#) as “water frequented by fish and any other areas on which fish depend directly or indirectly in order to carry out their life processes, including spawning grounds and nursery, rearing, food supply and migration areas”. Section 35.1 of the [Fisheries Act](#) states that the Minister of Fisheries and Oceans Canada may issue a permit to carry on any work, undertaking or activity which the Minister considers likely to result in the death of fish or the harmful alteration, disruption or destruction of fish habitat. Also, Section 36 (3) of the [Fisheries Act](#) states that “no person shall deposit or permit the deposit of a deleterious substance of any type in water frequented by fish or in any place under any conditions where the deleterious substance or any other deleterious substance that results from the deposit of the deleterious substance may enter any such water”.

Certified designers and certified installers are responsible for ensuring that there are no species listed under the [Species at Risk Act](#) (see the [Species at Risk Public Registry](#)) or critical habitat or residences of endangered or threatened aquatic species present in the work zone or the vicinity of the works, undertakings and activities. The [aquatic species at risk maps](#) should be consulted to determine where at-risk populations occur and where critical habitats are located.

Other constraints placed on projects through legislation are those relating to the design, construction, or the carrying out of a watercourse/wetland alteration by specific clauses in various Acts and Regulations of the Legislature of New Brunswick and the Parliament of Canada. See Table 1-1.

Table 1-1 Provincial and Federal Acts and Regulations applicable to the Source and Surface Water Management Branch. **Note:** It is the applicant's responsibility to ensure compliance with the Acts listed in this table and any other applicable Acts of the Legislature of New Brunswick and the Parliament of Canada.

PROVINCIAL

Clean Environment Act	Water Quality Regulation (82-126) Environmental Impact Assessment Regulation (87-83) Petroleum Product Storage and Handling Regulation (87-97)
Clean Water Act	Watercourse and Wetland Alteration Regulation (90-80) Wellfield Protected Area Designation Order (2000-47) Watershed Protected Area Designation Order (2001-83)
Crown Lands and Forests Act	Timber Regulation (86-160) Lands Administration Regulation (2009-62)
Heritage Conservation Act	General (H-4-05)
Protected Natural Areas Act	Establishment of Protected Natural Areas Regulation (2003-8) General Regulation (2004-57)
Species at Risk Act	List of Species at Risk Regulation (2013-38) Prohibitions Regulation (2013-39)
Fish and Wildlife Act	Wildlife Refuges and Wildlife Management Areas Regulation (94-43)

FEDERAL

Impact Assessment Act	Purposes (Sec. 6) Prohibitions (Sec. 7)
Canadian Environmental Protection Act	Objectives, Guidelines and Codes of Practice (Sec. 54)
Fisheries Act	Purposes (Sec 2.1) Fish and Fish Habitat Protection and Pollution Prevention (Sec. 34 - 42) Regulations (Sec. 43)
Species at Risk Act	Purposes (Sec. 6) General Prohibitions (Sec. 32) Protection of Critical Habitat (Sec. 56)
Canadian Navigation Waters Act	General (Sec. 5, 6, 15, 16, 21, 22, 23)

1.3.8 Permitting System

An application for a watercourse and wetland alteration permit must be completed and submitted to DELG for all alterations proposed within 30 metres (100 ft) of a watercourse or wetland. No watercourse or wetland alteration may begin until a permit is granted or that DELG has confirmed that a permit is not required.

The permitting system consists of the following types of permit:

- Standard: issued for a single alteration
- Multiple: issued for multiple alterations with a common factor
- Provisional: issued for alterations that potentially have little to no detrimental impact on a watercourse/wetland
- Renewal: issued for alterations not commenced or completed in the period the original permit is valid for
- Revision: issued for modifications of the original project design, requiring further review and revision to a current permit

1.3.9 Working on Crown Lands

All activities on Crown Lands require approval from the New Brunswick Department of Natural Resources and Energy Development. The following applies to Crown Land:

- For licensees (and sub-licensees) working in or within 30 metres (100 ft) of a wetland: If the alteration complies with the *Forest Management Agreements* under the authority of the [Crown Lands and Forests Act](#), a WAWA (Watercourse and Wetland Alteration) permit from DELG is not required.
- For licensees (and sub-licensees) working in or within 30 metres (100 ft) of a watercourse that drains an area of 600 hectares, or less, at the site of the alteration: If the alteration complies with the *Forest Management Agreements* under the authority of the [Crown Lands and Forests Act](#), a WAWA permit from DELG is not required.
- For licensees (and sub-licensees) working in or within 30 metres (100 ft) of a watercourse that drains an area greater than 600 ha at the site of the alteration: A WAWA permit from DELG is required.
- For all non-licensees working in or within 30 metres (100 ft) of a watercourse/wetland, regardless of size*: A WAWA permit from DELG is required and landowner consent (from Crown Lands) is also required.

***Note:** Wetlands that are less than one hectare in area, and not contiguous to a watercourse are exempt in the [Watercourse and Wetland Alteration Regulation](#) and therefore do not require a WAWA permit.

1.4 COMPLETION OF TRAINING PROGRAM

Individuals successfully completing this training program will be granted a Watercourse Alteration Certified Installer Certificate, as part of the Watercourse Alteration Certification Program. Certified installers are then able to apply for permits for specific types of alterations performed during certain periods of the year.

1.4.1 Activities Permitted Under the Watercourse Alteration Certification Program

The permits issued under the Watercourse Alteration Certification Program include the following alterations.

- Installation and replacement of culverts:
 - closed-bottom: minimum diameter of 600 millimetres (24 in) or equivalent end area; maximum diameter/end area is the equivalent capacity for a drainage area of 20 km² (8 Mi²)
 - open-bottom: minimum span of 1.2 metres (4 ft); maximum span is the equivalent capacity for a drainage area of 20 km² (8 Mi²)
 - new culverts: maximum length of 25 metres (82 ft)
 - replacements: maximum length of 30 metres (100 ft)
- Maintenance and removal (decommissioning) of culverts
- Installation, replacement, maintenance, and removal (decommissioning) of single-span bridges (permanent)
- Vegetation clearing for watercourse crossing installation/replacement
- Stabilization measures for watercourse crossings, roads, and ditches
- Installation/construction of temporary bridges
- Beaver dam removal/management
- Placement of erosion protection works
 - Biotechnical (*i.e.* vegetation) products
 - Rip-rap/armor stone
- Water withdrawal (temporary or maintenance/replacement of permanent intake structure)
- Timber harvesting

Note: Although a certified installer may carry out any of these alterations (provided a Watercourse and Wetland Alteration (WAWA) permit has been obtained for the work), under the Watercourse Alteration Certification Program, the submission for the WAWA permit for watercourse crossings requiring designs and drainage area calculations can only be submitted by a certified designer.

1.4.2 Activities Permitted by a Certified Installer

The following is a list of alterations that a certified installer may request a WAWA permit under the Watercourse Alteration Certification Program:

- Maintenance and removal (decommissioning) of culverts
- Maintenance, and removal (decommissioning) of single-span bridges (permanent)
- Construction of approaches to a watercourse crossing
- Vegetation clearing for watercourse crossing installation/replacement
- Stabilization measures for watercourse crossings, roads, and ditches
- Installation/construction of temporary bridges
- Beaver dam removal/management
- Placement of erosion protection works
 - Biotechnical (*i.e.* vegetation) products
 - Rip-rap/armor stone
- Water withdrawal (temporary or maintenance/replacement of permanent intake structure)
- Timber harvesting

1.4.3 Responsibilities of Certified Installers

The responsibilities of certified installers include, but are not limited to, the following:

- Know, understand, comply with all relevant acts, regulations, standards, guidelines, permit conditions, requirements of the application process, and policies of DELG.
- Ensure consideration of best practices for environmental protection for all watercourse alteration sites.
- On-site supervision of each alteration to ensure compliance of all conditions listed on the WAWA permit.
- Ensure watercourse crossings are installed as per the designs and that fish passage is provided.
- Provide information to DELG in a timely manner when requested related to projects in which you are or were involved.
- The activities of any individual working on the project.
- The activities of any individual delegated as supervisor of the project.
- Execution of the project in an environmentally responsible and diligent manner.
- The reporting of any spills or environmental mishaps to the appropriate authority throughout the duration of the project.

1.5 AUDITING WATERCOURSE AND WETLAND ALTERATIONS

All watercourse and wetland alterations are subject to audit at any time. Audits can be carried out by inspectors with DELG, the New Brunswick Department of Natural Resources and Energy Development, the New Brunswick Department of Justice and Public Safety, and staff from Fisheries and Oceans Canada.

Inspectors will be looking at all aspects of the alteration, including, but not limited to, installation, construction, stabilization, and follow-up maintenance.

Failure to comply with the requirements of the Watercourse Alteration Certification Program and/or any associated permit conditions may result in an investigation that may result in an Order to remediate any damage and/or possible prosecution. DELG also reserves the right to revoke an individual's certification status should the requirements of the Watercourse Alteration Certification Program not be adhered to. See Section 1.4.3 *Responsibilities of Certified Installers*.

2.0 WATERCOURSE AND WETLAND ALTERATION PERMITS FOR CERTIFIED INSTALLERS

2.1 WATERCOURSE ALTERATION CERTIFICATION PROGRAM

The Watercourse Alteration Certification Program was developed to allow individuals to apply through a one-window approach for Watercourse and Wetland Alteration (WAWA) Permits that qualify under the program. For a list of alterations that can be carried out under the Watercourse Alteration Certification Program, see Section 1.4.1 *Activities Permitted Under the Watercourse Alteration Certification Program*.

The Watercourse Alteration Certification Program was divided into two courses/manuals in 2022. The first was developed to allow individuals to become certified in all aspects of the program. The second course for certified installers has been developed for individuals that are involved in all aspects of a watercourse alteration, except for the sizing and designing of watercourse crossings.

An individual's certification will remain valid for a period of 10 years (unless revoked). At the end of this period, a certified installer must take the full Watercourse Alteration Certification Course for Certified Installers to renew his/her certification status. If major changes are made to the program (*i.e.* regulatory, technical guidelines, etc.), a re-certification may be required before the 10-year expiry.

A public list of certified designers and installers will be maintained so that clients that wish to consult with a certified individual for WAWA permits may do so. Only individuals that opt to be on a public registry will appear on it. These individuals will be able to apply for WAWA permits through the Watercourse Alteration Certification Program on behalf of other clients.

2.2 PERMIT APPLICATION PROCESS

Certified installers must apply for each alteration site using the [online application program](#). The information required during the application includes:

- The certified installer's ID number and contact information
- The location of the alteration
- A *Watercourse Alteration Certification Data Sheet* (a sample of this form is included in the Appendices at the end of this manual)
- Photos and drawings (plans) as required
- Payment
- Landowner consent (if the applicant is not listed as the current landowner with Service New Brunswick records)

When using the [online application program](#), a confirmation email will be sent showing that the application was successfully submitted. This email, which also contains a

reference number of the application, should be retained by the applicant until a permit has been issued.

A single permit will be issued for each alteration site. The permit will be site-specific and will contain conditions for that specific alteration type.

Information regarding any work in progress or completed under a WAWA permit must be made readily available, upon request, to any inspector of the New Brunswick Department of Environment and Local Government, the New Brunswick Department of Natural Resources and Energy Development, the New Brunswick Department of Justice and Public Safety, or staff with Fisheries and Oceans Canada for auditing or inspection purposes.

PLEASE BE ADVISED

A copy (paper or electronic) of the Watercourse and Wetland Alteration Permit must be kept at the work site at all times while the work is in progress.

2.3 REVIEW PROCESS

WAWA permit applications submitted under the Watercourse Alteration Certification Program will be reviewed using a tiered approach based on risk. Each tier has been developed to ensure that, in addition to the requirements of the New Brunswick [*Watercourse and Wetland Alteration Regulation*](#), the requirements under the federal [*Fisheries Act*](#) are also met. This review process will allow the federal Department of Fisheries and Oceans (DFO) to evaluate the projects being submitted for approval. See Table 2-1 for a list of alterations covered under the Watercourse Alteration Certification Program, along with their respective approval requirements.

Tier 1 review (low risk): These projects can be submitted through the Watercourse Alteration Certification Program. Permit issuance is aimed at 5-day turnaround time (provided all information required has been submitted and is in good order). These applications will be reviewed by DELG without consultation with DFO.

Tier 2 review (medium risk): These projects can be submitted through the Watercourse Alteration Certification Program. Permit issuance aimed at 15-day turnaround time (provided all information required has been submitted and is in good order). These applications will be reviewed by DELG and DFO. If fish passage is not properly provided on the submitted plans, the applicant will be advised within 15 days of submission that the application is incomplete for review. The approval of the project will then be dependent on when the proper information is received.

Tier 3 review (high risk): These projects do not qualify under the Watercourse Alteration Certification Program and require a standard WAWA permit.

Table 2-1 Alterations permitted under the Watercourse Alteration Certification Program and corresponding tier review level

<u>Alteration</u>	<u>Tier 1</u> (low risk)	<u>Tier 2</u> (medium risk)	<u>Tier 3</u> (high risk) Requires standard WAWA Permit
Constructing or replacing single span bridge	X		
New open-bottom culvert (max length 25 m, max drainage area 20 km ²)	X		
Replacing open-bottom culvert (max length 30 m, max drainage area 20 km ²)	X		
Replacing closed-bottom culverts (0-0.5% slope, max length 30 m, max drainage area 20 km ²)	X		
Replacing closed-bottom culverts with twin pipes (0-0.5% slope, max length 30 m, max drainage area 20 km ²)	X		
Replacing a closed-bottom culvert with an open-bottom culvert or bridge (max length for culvert 30 m, max drainage area 20 km ²)	X		
Removal (decommissioning) of watercourse crossings	X		
Temporary bridge over a watercourse or wetland (between June 1 - March 19)	X		
Temporary wetland crossing (footprint less than 100 m ²)	X		
New closed-bottom culvert (0-0.5% slope, max length 25 m, max drainage area 20 km ²)		X	
Closed bottom culverts with baffles (0.51-5% slope, max length 25 m (30 m for replacements), max drainage area 20 km ²)		X	
Stream simulation culvert (0-6% slope, max drainage area 20 km ²)		X	

Replacing an open-bottom culvert or a bridge with a closed-bottom culvert (0-5% slope, max length 30 m, max drainage area 20 km ²)		X	
Any watercourse crossing not sized to meet the 1 in 100-year flood event			X
Closed-bottom culvert that does not provide fish passage			X
Multiple (more than two pipe) closed-bottom culverts			X
Closed-bottom culvert installation or replacement where there is a listed aquatic SAR or SAR-habitat			X
Open-bottom culvert replacement with reduces end-area or extended footprint where there is a listed aquatic SAR or SAR-habitat			X
Constructing a bridge with instream support(s)			X
Beaver dam management and removal	X		
Bank protection projects (biotechnical/vegetation or rip-rap/armor stone)	X		
Placing bank protection products on watercourses where there is a listed SAR or SAR-habitat			X
Water withdrawal (temporary or maintaining permanent intake structure)	X		
Timber harvesting	X		
Any alterations resulting in a permanent wetland impact greater than 100 m ²			X
Any alterations in and within 30 m of a provincially significant wetland (PSW)			X
Any alterations within a designated watershed or wellfield used as a source for public water supply			X

2.4 PERMIT EXCLUSIONS

The Watercourse Alteration Certification Program **does not** allow for the following alterations. In any of these situations, an application for a standard WAWA permit must be submitted for review. These applications will be reviewed by DELG and may also be reviewed by DFO and other advisory agencies.

- Alterations within a protected area water supply watershed that is being used as a source of water for a public water supply system, as defined in the [Watershed Protected Area Designation Order – Clean Water Act](#)
- Alterations within a designated wellfield that is being used as a source of water for a public water supply system, as defined in the [Wellfield Protected Area Designation Order – Clean Water Act](#)
- Alterations resulting in a permanent wetland impact greater than 100 square metres (1076 ft²)
- Alterations in or within 30 metres of a provincially significant wetland (PSW)
- Alterations that require an Environmental Impact Assessment registration under the [Environmental Impact Assessment Regulation - Clean Environmental Act](#)
Note: If the alteration is part of a project that has already been determined under the EIA process, a certification permit may be applied for, provided a copy of the Certification of Determination is included in the application package.
- Alterations where there is an aquatic species at risk under the [Species at Risk Act](#) that is subject to the DFO Critical Habitat Order may require a standard WAWA permit. These areas include the habitat for the Inner Bay of Fundy Salmon and Lake Utopia Rainbow Smelt. Alterations that will require a standard WAWA permit include the installation of erosion and bank protection products, the installation of new closed-bottom culverts, and the replacement of a watercourse crossing structure where there is a reduction of end-area or extension in footprint.

2.5 WETLANDS

The [Watercourse and Wetland Alteration Regulation](#) states that any alteration within 30 metres (100 ft) of a wetland that is greater or equal to 1 hectare in size, or contiguous to a watercourse, is regulated and requires a WAWA permit.

On January 1, 2020, DELG created a [Watercourse and Wetland Alteration \(WAWA\) Reference Map](#). The map is based on a composite of the most recent, publicly available information on watercourse and wetland locations and is to be used as a reference tool. All wetlands are now regulated by their presence on the ground as per the definition in the [Clean Water Act](#).

Under the [Clean Water Act](#), a wetland is land that, either periodically or permanently, has a water table at, near, or above the land's surface or that is saturated with water and sustains aquatic processes as indicated by the presence of hydric soils, hydrophytic vegetation, and biological activities adapted to wet conditions.

In assessing potential developments in or near wetlands, the first step should be to avoid and minimize the impact to the wetland to the extent possible. A desktop review and a site visit should be carried out to determine the presence of a wetland.

If the project results in the permanent impact of a wetland, a *Wetland Identification Data Sheet* may be required to confirm that the project will not result in more than 100 square metres (1076 ft²) of permanent wetland impacts (a sample of this form is included in the *Appendices* at the end of this manual). This data sheet must be filled out by someone qualified, meaning a person having a combination of training in wetland identification and delineation based on the North-Central and Northeast Regional Supplement of the U.S. Army Corps of Engineers Wetlands Delineation Manual (1987) or an equivalent pending review from the Source and Surface Water Management Branch and; education and/or demonstrated experience in wetland hydrology, soils, botany and/or related sciences. See Figure 2-1 for additional information on when the Wetland Identification Data Sheet may be required.

Figure 2-1 Wetland identification requirements

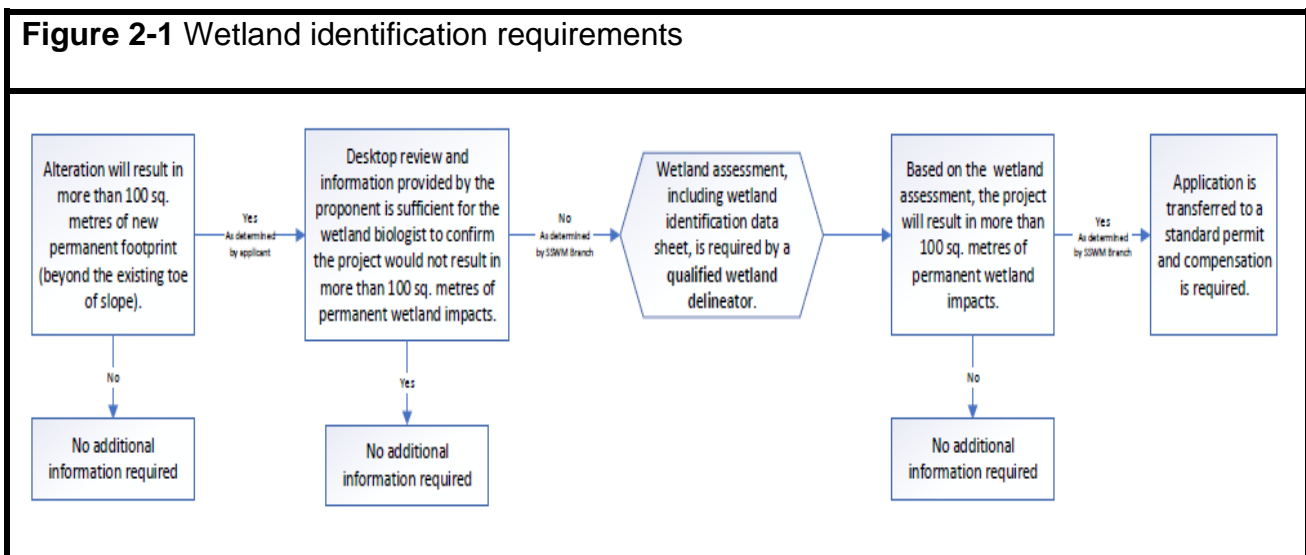

In conformity with the [Wetland Guidelines](#), maintenance and upgrades to existing infrastructure that result in no more than 100 m² (1076 ft²) of permanent wetland impacts are exempt from the compensation requirement.

The Watercourse Alteration Certification Program allows for certain alterations where wetlands are present provided:

- The alteration meets the criteria in Section 1.4.1 *Activities Permitted Under Certification*
- The wetland is not a provincially significant wetland (PSW)
- The temporary impact within a wetland is restored to the original grade following completion of the project

Alterations allowed under the Watercourse Alteration Certification Program where wetlands are present include:

- Timber harvesting (not permitted within non-forested wetlands)
- Removal of non-merchantable vegetation (for brush maintenance within right-of-ways and clearing activities associated with watercourse crossing installation/replacement)
- Temporary bridges
- Temporary wetland crossings with footprint less than 100 m² (1076 ft²)
- Beaver dam management
- Water withdrawal from watercourses where wetlands may also be present (not permitted directly from wetlands)
- Replacements, maintenance, and upgrades to existing infrastructure (roads, culverts, single-span bridges, and erosion protection works) provided the alteration results in a maximum of 100 m² (1076 ft²) of permanent wetland impact.

3.0 IMPACTS OF WATERCOURSE ALTERATIONS

Any alteration to, near, or in a watercourse may impact the watercourse and its aquatic habitat negatively. Alterations must therefore be carefully planned before they begin. The following information describes basic parameters of watercourses, potential negative impacts from alterations, and their effects on the aquatic environment.

3.1 BASIC PARAMETERS OF WATERCOURSES

The following highlights some basic parameters that can be impacted by watercourse alterations. It is important to keep in mind that the parameters of watercourses can differ greatly (e.g. the Petitcodiac River versus the Miramichi River) and the value of each of the parameter listed below is evaluated on a case by case during the permitting review process.

- **Water clarity** is essential for fish to find food, food production, oxygen up-take, and migration.
- **Dissolved oxygen** levels must be optimal for fish survival throughout all stages of life.
- **Water temperature** needs to remain cool and at an optimal temperature to maintain fish and fish habitat. The range of ideal temperature is dependent on the species present in the watercourse. Warmer temperatures decrease the level of dissolved oxygen.
- **Gravel substrate** must remain clean for spawning to be successful and incubating eggs to survive.
- **Fish passage** must remain unobstructed for successful migration to occur.

3.2 EROSION

Erosion is the detachment of soil particles and loss of surface material from the Earth's surface by the action of gravity, ice, water, wind, or as a result of other natural occurrences or human-induced events. Throughout an alteration, exposed soil may accelerate the rate of erosion if protective measures are not properly employed.

If erosion does occur at an alteration site, it could have the following impacts on:

- Fish/fish habitat
 - Disruption of migration patterns due to large amounts of erodible material blocking the upstream and downstream reaches
 - Reduction in the food supply as a result of a loss of vegetation along the banks and adjacent areas
 - Reduction in areas providing shelter to small fish
 - Elimination of rearing pools, holding areas, and spawning grounds as a result of sediment deposition

- Water quality
 - Increase in water temperature and decrease in the amount of cover, shade, and food for aquatic organisms due to the loss of vegetation along the banks and adjacent areas, and/or bank failure
 - Changes in the water chemistry and aquatic species in response to increased levels of nutrients such as nitrogen and phosphorus

3.3 SEDIMENTATION

Sedimentation is the deposition of fine particles, such as sand, silt and clay, which have been dislodged from exposed soils and transported by water. It is a natural but potentially serious consequence of erosion, which may be accelerated by an alteration. Sedimentation is divided into two categories based on how the stream flow propels it:

- **Suspended sediment:** Soil particles suspended in the water column. Suspension is dependent on particle size.
- **Bedload movement:** Soil particles that slide, roll, or bounce along the bed of the watercourse. These particles may be too heavy, or the stream flow velocity is too slow to be suspended in the water column.

If sediment is present in a watercourse, it may have the following impacts on:

- Fish/fish habitat
 - Suffocation of fish due to the clogging of the gill surface membranes
 - Suffocation of fish eggs and fry due to sediment filling the interstitial spaces in the gravel
 - Hyperventilation in response to extreme stress causing an increase in mucus production
 - Abrasion or scraping of gill membranes and fish scales
 - Disruption of spawning activities due to stress
 - A negative impact on feeding efficiency due to decreased visibility
 - Reduction in food supply due to a decrease in photosynthesis affecting algae and other aquatic plants
 - Reduction in food supply due to a decrease in aquatic invertebrate populations
 - Reduction in suitable spawning areas due to the interstitial spaces between rocks, rubble, and gravel being filled in
- Water quality
 - Increased water temperature and decreased oxygen levels due to changes in water depth as a result of sediment deposition
 - Decreased visibility as water clarity diminishes due to an increase in turbidity

3.4 METHOD OF DEFENSE

Detrimental effects can occur as a result of short term or continuous long term exposure to varying levels of erosion or sedimentation. The best method of defence is to ensure that all protective measures are planned before commencing work and properly utilized/maintained throughout the work.

4.0 SURVEYING FOR WATERCOURSE CROSSINGS

Given the technicalities, standards, and guidelines that are required when installing or replacing instream structures, surveying plays a vital role in ensuring that proper designs are developed. This information can be easily translated into building a set of construction plans that detail all of the crucial vertical and horizontal measurements within a watercourse crossing. This will ultimately confirm that the structure is installed as per design. In doing so, all new structures have a good opportunity to last for its intended life, while also providing fish passage.

When conducting a survey, it is essential to gather all the relevant on-site information that may influence the design and construction of the crossing. A design requires a stream and road survey as well as the recording of the applicable watercourse and land features.

4.1 TERMINOLOGY

Benchmark: A surveyor's mark on a construction site that is used as a reference point in measuring elevations. A benchmark is critical whenever elevations are measured to transfer site-specific information to a plan.

Instrument: A device that is utilized for surveying to collect vertical elevations and horizontal angle information. (Examples include: Total Station, Theodolite, Transit Level, Builders Level, Laser Level, etc.)

Levelling rod: A graduated pole with a movable marker, held upright and used with a surveying instrument to measure differences in elevation.

Elevation: The recorded instrument reading (vertical height) taken in a survey. When using a simple level, this value is equal to the height from the ground to the height of the instrument at any given point within your construction site. When using an instrument that records x,y,z data (i.e. Total Station), elevations can be related to sea level.

Bankfull Width/Stage:

The width of the bankfull channel measured at a section perpendicular to the stream flow at bankfull discharge. Typically, the width of the channel where water leaves the channel and enters a flood plain. See Section 1.3.5 *Determining Channel Width* and Figure 4-1.

Figure 4-1 Measuring the cross-section of a channel

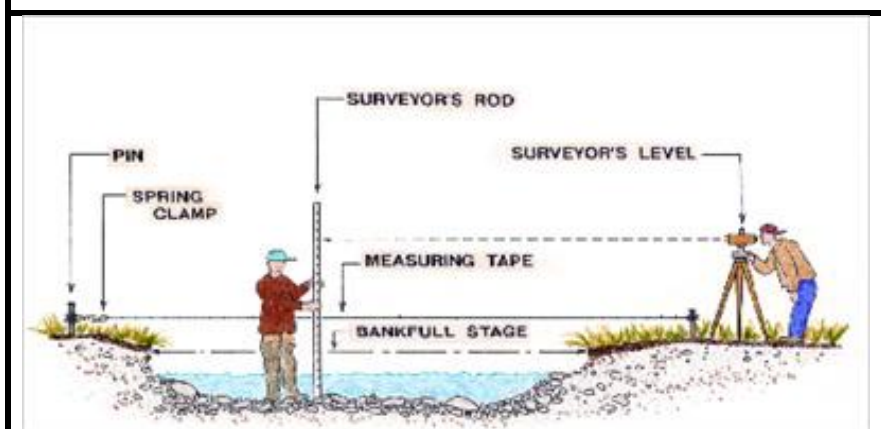

Thalweg: The line defining the lowest points along the length of a watercourse; the lowest channel of flow within a watercourse; also known as the current. See Figures 4-2 and 4-3.

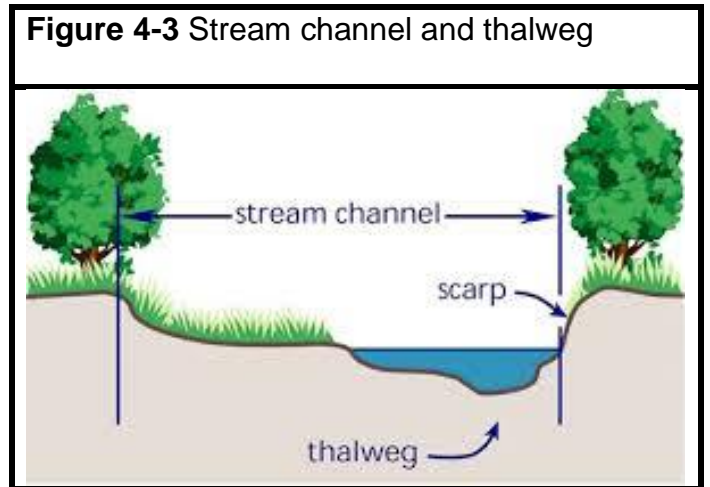
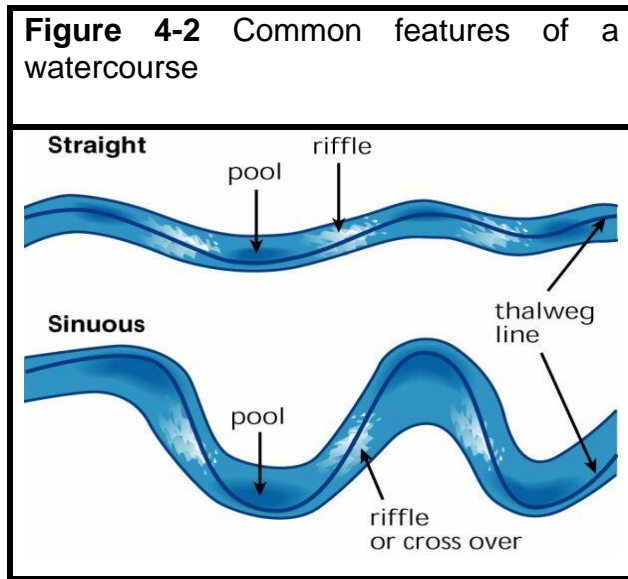

Riffle: Shallow water extending across the bed of a flowing watercourse with rapid current and with surface flow broken into waves by submerged obstructions such as gravel and cobble. In other words, a small set of rapids or a small dam, which creates the pool. See Figures 4-4 and 4-5.

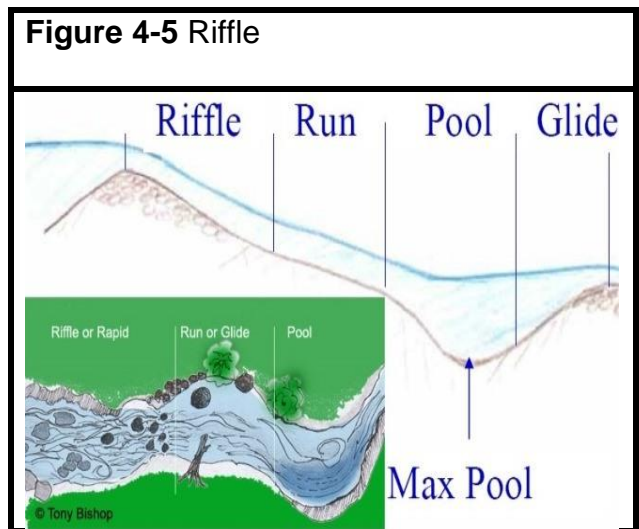
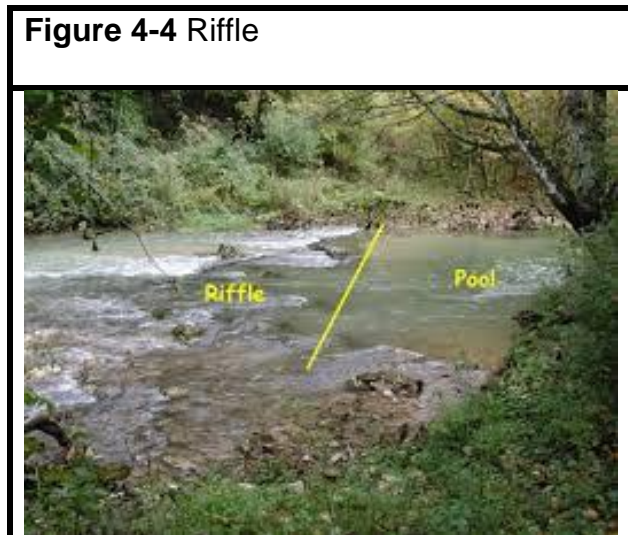

4.2 SURVEYING

Surveying allows for the translation of existing stream and road elevations to a set of construction plans. This information is essential when design decisions are made. It ensures that all elevations captured represent the actual existing state of the stream and road. It is also beneficial when installing and aligning new structures to fit the given site.

Failure to ensure that structures are installed at the correct design elevations can impact the functionality of the structure, including its ability to pass fish.

Note: A trained surveyor working on large projects today is equipped with surveying units much more advanced and technical than the site level shown in Figure 4-6. However, the basics of surveying have remained unchanged. The majority of stream surveys related to certification projects are meant to be straight forward, and most of them can be completed using the simplest form of surveying. These methods are very basic and can be learned by anyone that is willing.

Figure 4-6 Surveyor's site level



4.3 EQUIPMENT

Common equipment used to survey include:

- Transit level, tripod, and leveling rod
- Clipboard, blank paper, and a pencil
- Survey spreadsheet to record data
- Maul and re-bar or nail
- Ribbon and orange spray paint
- Axe or hatchet
- 7.5 metre (25 ft) tape measure
- 100 metre (300 ft) tape measure
- GPS

4.3.1 How to Set Up a Transit Level

- 1) Secure and anchor the tripod to a stable position and adjust legs to an appropriate height for viewing.
- 2) Place the level directly on the tripod head and attach it to the base using the thread bolt (hand tighten only).
- 3) Remove the protective lens covers and place them in the carrying case.

4.3.2 Leveling and Using the Instrument

- 1) Ensure that the tripod is stable and securely planted to prevent tip-over before starting the instrument levelling process.
- 2) Ensure that the attachment between the transit level and the tripod is secure.
- 3) Ensure that the four levelling screws are set to a neutral position to allow fine adjustments in both directions (up and down).
- 4) Attempt to rough-level the instrument by simply adjusting the legs of the tripod, while watching the levelling bubble. This will make fine adjustments that much easier.
- 5) Place the levelling screws between your thumb and forefinger; turn two screws at the same time in opposite directions and watch for movement in the levelling bubble. Adjust the instrument 90 degrees, so that it sits over the next two adjustment screws and repeat. Continue this step for all three screws until the bubble is centred.
- 6) Move the instrument through various stages of the 360° and check if the instrument is level at all points.

If the instrument is not level at all points, the final check must be done again until the bubble is centred at each point. If the bubble does not get centred, there may be damages to the levelling instrument.

4.3.3 How to Read a Transit Level

- 1) Locate the eyepiece. This component can be adjusted to bring the crosshairs into focus.
- 2) All instruments are equipped with a focusing knob. Locate and adjust as required.
- 3) All instruments have a course sight-in located on the top of the instrument. It's a lot quicker to utilize this tool to locate the levelling rod.
- 4) Look through the eyepiece and use the horizontal alignment adjustment knob to center the levelling rod within the scope.
- 5) To complete this stage, identify the number from the levelling rod that corresponds with the center horizontal line (crosshair) in the eyepiece.

4.3.4 Helpful Hints for Levels

- When the objective lens is not in use, it should be covered with a lens cap to prevent damage to the equipment.
- Detachable sunshades are useful in preventing glare and protecting the objective lens.
- DO NOT lift your level by the telescope; always lift it by the base.
- Ensure to turn both screws at the same time and rate when levelling a transit level.
- Ensure the transit level is level around all 360° of direction; if this is not done, the measurements will be incorrect.
- Ensure the levelling screws are not too tight; overtightened screws will need to be loosened for the most accurate results. Also, if the screws are too tight, they may warp the base plate, causing permanent damage.

- DO NOT look at the sun through the telescope.
- Keep both eyes open when looking through the telescope. This will avoid tiring your eyes and eliminate squinting.
- The jumping of an image is called parallax. With each movement, adjust the focusing knob until the image stops jumping.
- DO NOT touch the tripod once the transit level is mounted. This can cause problems with the measurements as well as the accuracy of the level.

4.3.5 Common Levelling Mistakes

Common mistakes made while levelling are summarized below, along with steps to avoid mistakes.

- Rod section skipped. Fully extend all sections of the rod before starting.
- Rod is not vertical. Stand directly behind the rod. Hold the rod with two hands, lightly grip and balance the rod with both hands.
- Rod held on the wrong point. Communicate clearly to rod person exactly where to place rod.
- Other tips:
 - Try to set up to read at least one-foot above surfaces that are warm to avoid heat waves
 - Set up to keep sights as short as possible
 - Set up to keep backsights and foresights nearly equal in length
 - Use solid benchmarks that can be easily found by others

4.3.6 Calculating Difference of Elevation

To calculate the difference in elevation between two points, a direct reading can be taken on the levelling rod at each point. The difference in elevation is determined by subtracting

the lower reading from the higher reading. See Figure 4-7.

If more than two points are involved, then a levelling procedure is used. The procedure involves starting at the

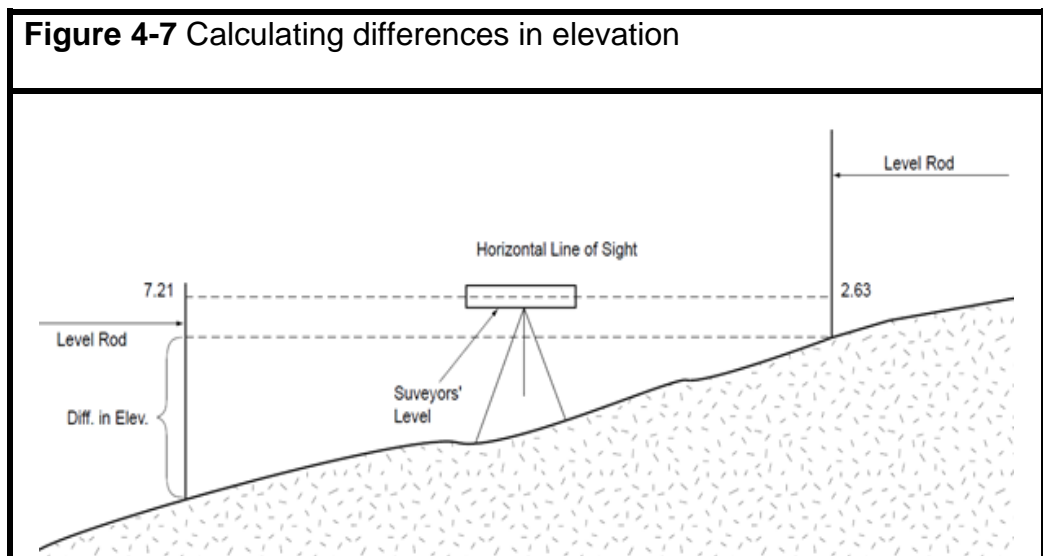

benchmark, establishing the height of the instrument, and then taking rod readings on points where new elevations are to be established. See Section 4.5.2 *Reducing Elevations*.

4.4 SETTING BENCHMARKS

Benchmarks should be set in a stable location that is:

- Far enough from the site, so they are not impacted by construction, but close enough for accessibility. Set two benchmarks in the event one is moved or destroyed.
- Close to a road so that they can be found easily, but not too close that they are impacted by grading and plowing.
- Clearly visible (ribbon or paint), given that vegetation could grow around it in several months, making it very difficult to locate.

There are several options to consider when creating a benchmark. Regardless of which strategy used, the most important rule of thumb to consider is to make sure that its location does not move. You will have to consider the time of year (frost, snow, ice), machinery (*i.e.* graders, plowing), tree mulching, or any other possible activity that could influence the x,y,z coordinate of the site. Benchmarks can be made from a painted mark on ledge rock, a spike or nail in a mature tree, or a cut-off stump. A three-foot spike (cut-off re-bar) driven into the ground (deep enough to prevent frost heaving) also works well.

Once a benchmark is set, all elevations are now referenced from this point.

4.5 SITE SURVEY

4.5.1 Begin Survey

- Draw a site sketch. Try to capture all relevant information (*e.g.* road and direction, stream, riffles, pools, power lines, wetland, flood plain, benchmarks, culvert). See Figure 4-8.
- Record benchmark elevations. Take a grid and label elevation on drawing.
- Record road survey elevations; 10 metre intervals work well. The goal is to capture enough elevations in both directions so that you know where to tie in if your proposed site requires a road lift. When the proposed design is complete, the transition from the existing road through your new site should almost be unnoticeable when driving. Start at Road/Culvert center and proceed in each direction with your shots.
- Record instream elevations, but make sure first to run a tape to measure your distance. Five metre intervals will suffice along with important stream characteristics, such as an existing culvert inlet/outlet, riffles, meanders, and pools. You can record this on a generic spreadsheet as you will find that your drawing will get too cluttered. See Table 4-1.

- By capturing the existing elevations of both the stream and road (when replacing a culvert) through a survey, while also collecting all relevant details and expressing them on a plan view, a final 'Existing' drawing can be made. Capturing and drawing the existing conditions in a plan view is a crucial step to transitioning into the design phase.

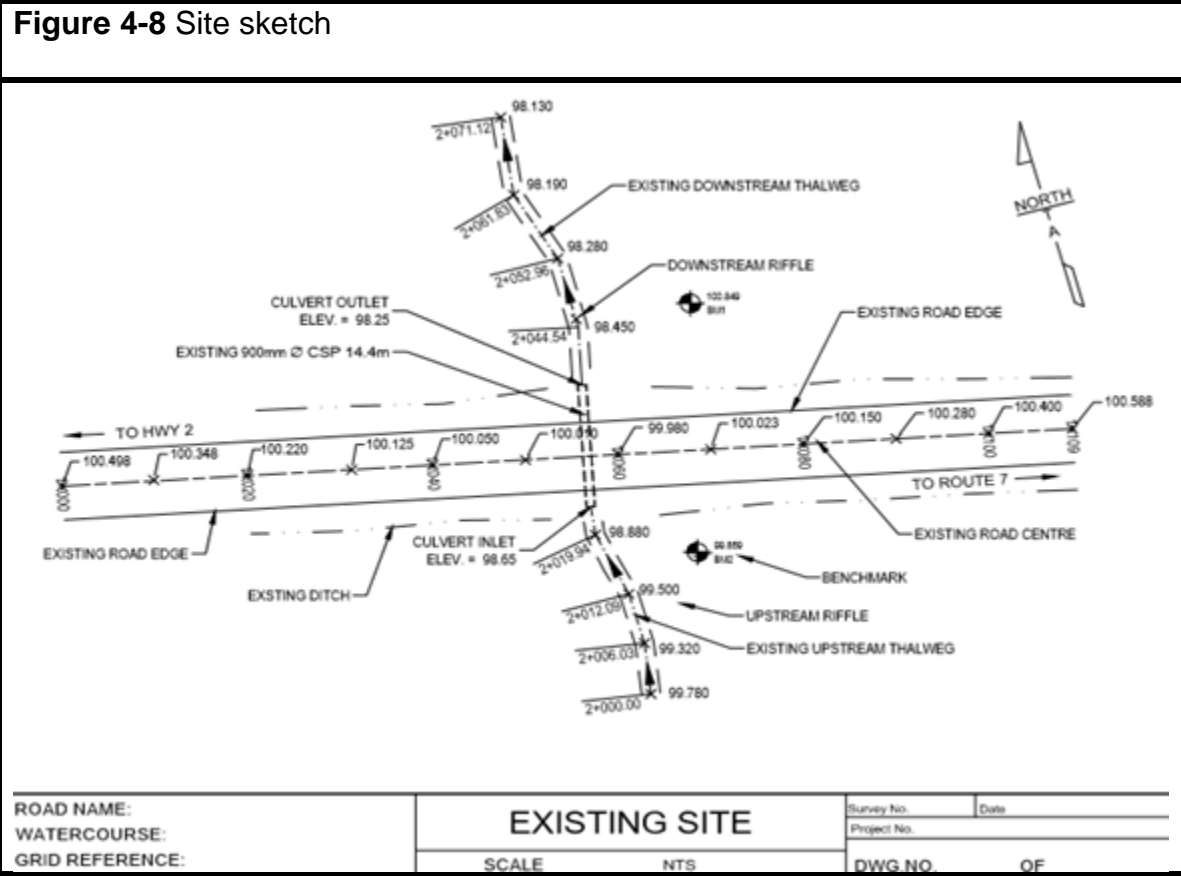

for when you move upslope, your recorded numbers get smaller. Reducing elevations simplifies all of your data set so that higher elevations have a higher value, and lower elevations have lower values. It's much easier to read a plan this way.

For example, it is very common for the main benchmark used on site to be set arbitrarily at 100.00. All elevations will now be above or below this benchmark, as indicated on the site.

For example, the rough elevation of the benchmark is 1.50 metre (reading on the rod).

To reduce all further elevations and to set this benchmark as our reference point; Add 1.50 metre (height of instrument) to 100.00 = 101.50.

Subtract all rough field elevations from 101.50.

In doing so, we have subtracted the height of the instrument and set this benchmark to 100.00.

4.6 CREATE A WATERCOURSE PROFILE DIAGRAM

Using the survey data, create a watercourse profile diagram. See Figure 4-9 for an example of a watercourse profile diagram created with field-collected data.

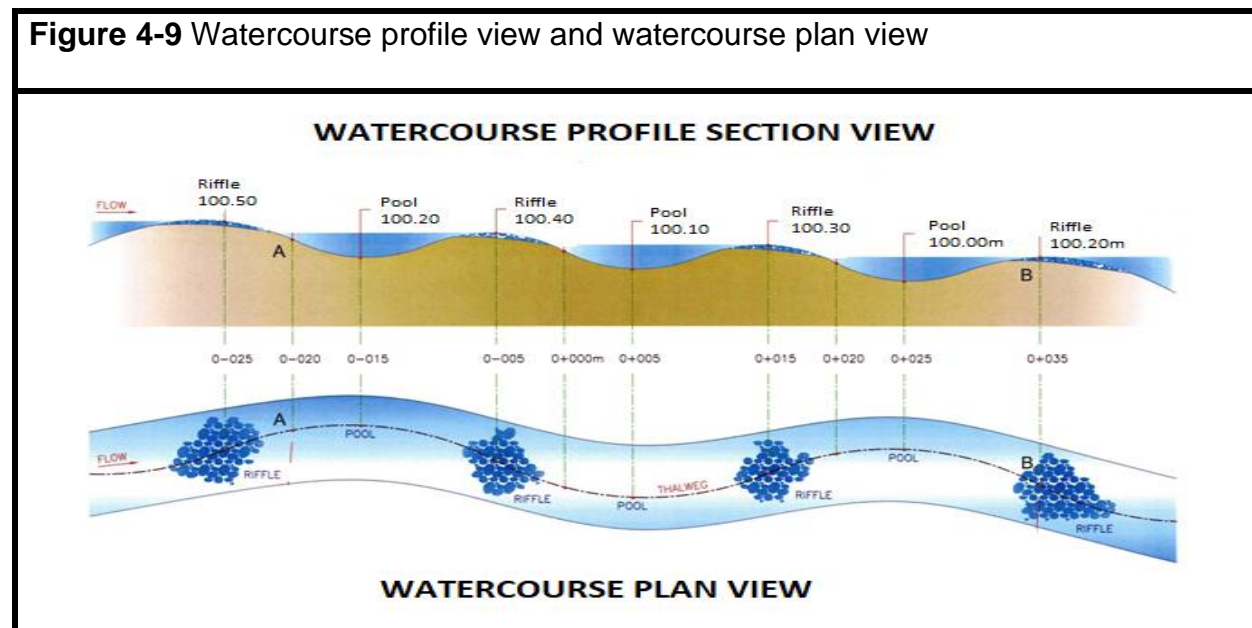

All of the collected field data can now be used to create a plan for the installation of the watercourse crossing.

5.0 GENERAL REQUIREMENTS FOR ALL WATERCOURSE ALTERATIONS

5.1 WATER CONTROL MEASURES WHEN WORKING IN A WATERCOURSE

All work in a watercourse must be completed in isolation of the stream flow to avoid sedimentation of the watercourse. Keeping the work area isolated from the stream flow also creates a work area where excavation and construction can be completed properly.

Construction activities within and immediately adjacent to the channel of a watercourse must be isolated from the stream flow to reduce the impact of silt and fines on water quality affecting aquatic life and other users. Water control measures are to be temporary to allow the work to proceed while minimizing impacts to the aquatic environment. This can be accomplished using cofferdams, temporary diversions, and/or dam and pump around techniques. Stream flow must be allowed to pass through or around a work site such that the flow in the watercourse is not interrupted.

For DTI and public roads:

Short duration pumping should be capable of handling (0.08 x drainage area) of flow, where drainage area is in km² and the flow is in m³/sec. Flows in excess of (0.08 x drainage area) typically pass through the worksite.

5.1.1 Sizing Requirement

Cofferdams must be of sufficient height and strength to hold back the bankfull flow and velocity.

The design and construction of temporary diversions and dam and pump methods should also withstand the full bankfull flow and velocity.

Additional equipment (*i.e.* pumps) and materials should be kept on-site in the event of high flows in the watercourse occurring after rainfall. Weather forecasts should be monitored, and instream work should be avoided during times of peak flows when possible.

5.1.2 Cofferdams

Cofferdams are temporary water barriers used to isolate the work area from flowing water. The following guidelines must be followed when using cofferdams:

- Cofferdams should be constructed of non-erodible material to prevent washout of the structure, which may result in downstream deposition and siltation
- Cofferdams should be of sufficient height and strength to prevent overtopping or collapse as a result of sudden increases in water levels

Figure 5-1 A view of a functional cofferdam isolating the construction area and the different types of cofferdams and their components

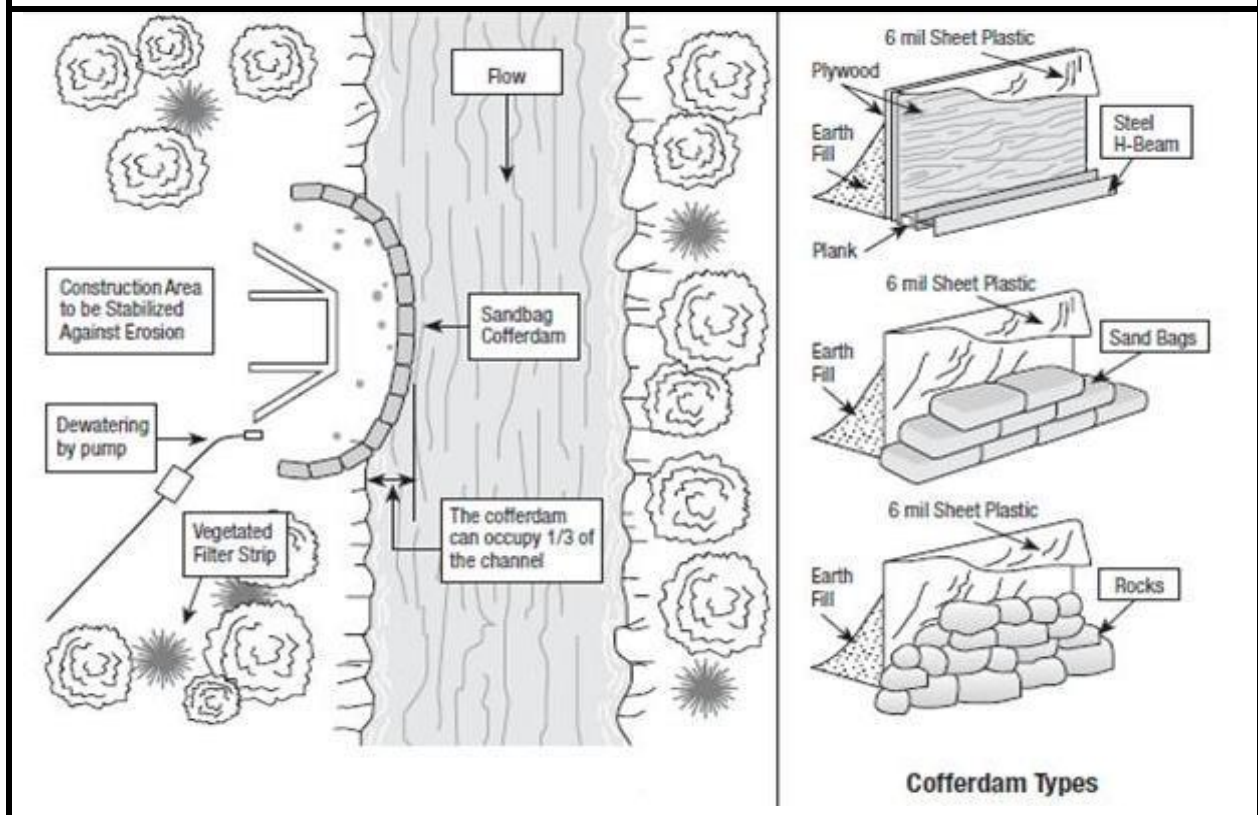

- Cofferdams must be constructed tightly to prevent or reduce the amount of seepage into the work area
- Cofferdams should consist of sheet piling or a layer of 6 millimetre plastic sandwiched between an inner wall of *in-situ* earth fill and an outer wall of either rocks, sandbags, or a steel H-beam attached to the bottom of a sheet of plywood. See Figure 5-1. Sheet metal or wood panel cofferdams are preferred over the construction of dams with till or pit run material as they can provide a tighter structure and do not create siltation and erosion problems. Sandbags filled with pea stone or clean granular material (free of fines) are also preferred as they can be removed easily. Several commercial engineered products are available for use. Standard or cubic metre sandbags are the most practical and most likely method of temporary water control barriers
- Excavation must not be carried out inside the cofferdam or sediment filtering device until the cofferdam curtain is completely closed
- Turbid water pumped from inside the cofferdam (construction space) must be pumped either into a settling pond, a filter bag, or onto existing vegetation of sufficient expanse to ensure there is no visible suspended sediment in the runoff returning to a watercourse/wetland

- The cofferdam material must be completely removed immediately upon completion of all work in the wetted portion of the watercourse, and the watercourse substrate must be restored to resemble pre-installation grades and profiles closely

Note: In small streams, a dam and pump or a temporary diversion will be required. In larger streams, as much of the channel as possible should remain open to allow unrestricted water flow and fish passage. A good practice is to leave at least two-thirds of the channel unobstructed at all times. See Figure 5-1.

5.1.3 Dam and Pump Method

Dam and pump method refers to stopping the flow upstream of the instream work area and pumping the flow around the site to a point immediately downstream of the work area. See Figure 5-2. This technique works best on smaller watercourses. The following guidelines should be followed:

- Construct an impermeable cofferdam to block the flow upstream. On the downstream side of the worksite, construct a second cofferdam above the discharge area. The cofferdam is intended to prevent the movement of sediment from the worksite into the watercourse, while also preventing backwater into the construction site.
- Fill used in the construction of a cofferdam must consist of only clean, sediment-free materials.
- Cofferdams should be of sufficient height and strength to prevent overtopping or collapse as a result of sudden increases in water levels.

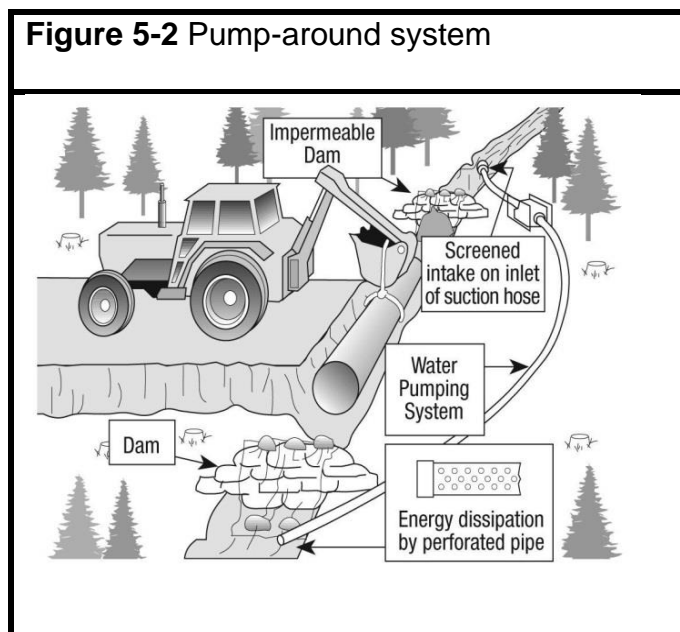

- Establish a water pumping system to transfer the natural stream flow directly downstream of the worksite. The water pumping system must be continuous whenever there is sufficient water to facilitate pumping until the installation is complete. Use one or more pumps capable of pumping all the stream flow past the worksite. The water pumping system must be monitored to ensure it operates in a functional conditions continuously throughout the entire period of use, including evenings and weekends.
- A complete back-up system should be kept on-site at all times to accommodate any increases in water flow and as a precautionary measure in case of breakdowns.
- Upstream of the installation site, locate the intake pipe where stream elevation is lowest. Movement of substrate material in the stream bed to accommodate the placement of the intake pipe must be done by hand.

- The water withdrawal must not cause any fish or other aquatic organisms to be removed from their habitat. The intake must be screened to prevent these organisms from entering the structure. For more information, please refer to the Fisheries and Oceans Canada's Code of Practice for End-of-Pipe fish protection screens for small water intakes in fresh water: <https://www.dfo-mpo.gc.ca/pnw-ppe/codes/screen-ecran-eng.html>.

Note: The installation of a fish net above and below the work site will prevent any fish from migrating in or near the pump area.

- Any time the existing channel is isolated from stream flow, a fish rescue is required. This will require the removal of any fish trapped in the isolated reach of the natural channel. Capture and relocate them immediately downstream of the temporary diversion. A license to collect and move fish may be obtained from Fisheries and Oceans Canada (DFO) prior to the fish rescue. Please contact DFO through the National Online Licensing System at <http://www.dfo-mpo.gc.ca/index-eng.htm>.
- The discharge hose should be located in areas with stable stream bed conditions. Use material such as 6 millimetre polyplastic, sandbags, or rock to stabilize the area where stable stream bed conditions are not available. Stabilization of the discharge area will prevent unnecessary scouring and erosion problems as a result of increased water volume and velocity.
- Turbid water from dewatering operations must be routed through a settling pond, filter bag, or into existing vegetation of sufficient expanse to ensure that there is no visible suspended sediment in the runoff returning to a watercourse/wetland.
- Upon completion of the construction project, remove first the downstream, then the upstream cofferdam from the watercourse. Restore/stabilize any soil disturbance along the stream banks or within the work area.
- After completion of the instream work, all materials must be removed from the watercourse.

5.1.4 Temporary Diversions

Use the following guidelines when constructing a temporary plastic or rock-lined diversion:

- Design the opening of the channel to accommodate the peak seasonal flows for the time period the diversion will be in place.
- The diversion channel must not be any longer than necessary to accomplish the project efficiently and must be excavated from the downstream end in isolation of the stream flow. See Figure 5-3.
- Excavate a temporary channel parallel to, and as close as possible, the existing stream channel. Leave a plug on both ends to ensure that stream flow does not enter the diversion channel.
- Line the temporary channel with plastic and secure with rock. Stake the plastic into place at the top of the channel side slopes and weigh the plastic down with rocks.

- Before the diversion channel plugs can be removed, ensure the area is isolated from flowing water (cofferdams/dam and pump).
- Any time the existing channel is isolated from stream flow, a fish rescue is required. This will require the removal of any fish trapped in the isolated reach of the natural channel. Capture and relocate them immediately downstream of the temporary diversion. A license to collect and move fish may be obtained from Fisheries and

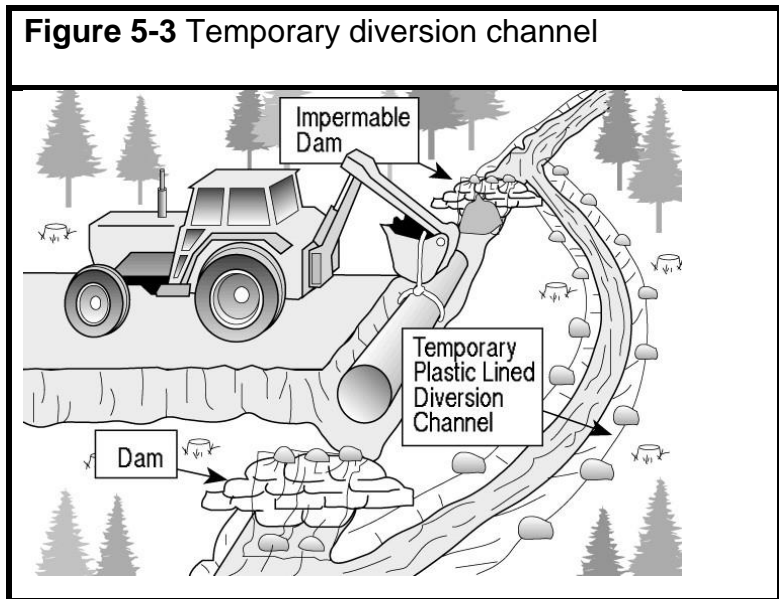

- Oceans Canada (DFO) prior to the fish rescue. Please contact DFO through the National Online Licensing System at <http://www.dfo-mpo.gc.ca/index-eng.htm>.
- Once in control of water, first, remove the plug at the downstream end of the diversion and stabilize the exit point. Second, remove the upstream plug and stabilize the entrance (plastic should be embedded below the thalweg to prevent flowing water from seeping underneath the plastic lining).
- Construct a cofferdam across the natural channel immediately below the entrance to the temporary diversion.
- To prevent backwater into the construction site in areas with little to no slope, construct a second cofferdam across the natural channel above its confluence with the temporary diversion.
- Turbid water from dewatering operations shall be routed through a settling pond, filter bag, or into existing vegetation of sufficient expanse to ensure that there is no visible suspended sediment in the runoff returning to a watercourse/wetland.
- Inspect the diversion channel daily and carry out repairs as required.
- Upon completion of the project, ensure the diversion channel is restored as closely as possible to the pre-project conditions.

5.2 EROSION PREVENTION AND SEDIMENTATION MANAGEMENT

Any soil exposure/disturbance, big or small, and especially near water can cause significant environmental issues.

BE SMART, BE PREPARED

In the event that something goes wrong before, during, or after construction, have a back-up plan and remediation material/devices on site. Remediation material/devices should include sandbags, rip-rap, filter bags, silt fencing, pumps, hoses, etc.

5.2.1 Environmental Considerations

Defined in basic terms, erosion is the wearing away of an exposed surface and sedimentation is the deposition of eroded particles. When erosion is minimized, the amount of sediment generated is reduced.

Sedimentation in watercourses is destructive to the aquatic habitat, whether the sediment remains suspended in the water or settles out. Environmental impacts, related to erosion and sedimentation, can be found in Module 3 *Impacts of Watercourse Alterations*.

Planning is critical to minimize erosion and sedimentation issues.

5.2.2 All Projects: Preventing Problems

If basic principles for the prevention of surface erosion and sedimentation are considered at the design stages of the project, potential problems can be minimized. These principles are as follows:

- Limit the size of the disturbed area. Retain existing vegetation wherever feasible. Erosion is minimal on a surface covered with natural vegetation.
- Limit the time the disturbed area is exposed.
- Establish permanent vegetation and surface cover. At a minimum, all exposed soils must be covered with grass seed and mulch (such as straw, wood chips, etc.) or with permanent surface cover such as gravel. For larger projects, keep the soil covered as much as possible with temporary or permanent vegetation or with various mulch materials.
- Ditches and swales may need to be lined with gravel, rock, or rip-rap to prevent erosion and scour of the soil. The size of material is dependent on the volume and velocity of the water flow during storm events.
- Exposed soil next to watercourses must be replanted with native perennial non-invasive species to establish natural habitat following project completion. The species and density of woody vegetation must be similar to that which existed in the area before the project took place.
- Keep clean water clean by diverting upland surface runoff away from exposed areas.
- Dykes and constructed swales may be used to divert runoff.
- Keep the velocity of surface runoff low. This can be accomplished by limiting the slope and gradient of disturbed areas and constructing check dams or similar devices in constructed swales and ditches.
- Plan construction to coincide with the low flow period from June 1st to September 30th of any given year.
- All stockpiled soil should either be covered with polyethylene or contained with a sediment control fence or mulch the stockpile as a temporary solution.
- Exposed soils must be managed until all erodible soils are permanently re-vegetated or stabilized with geotextile or rock.

- Turbid water must not be pumped directly into a watercourse. It must be routed through a settling pond, filter bag, or into existing vegetation of sufficient expanse to ensure that there is no visible suspended sediment in the runoff returning to a watercourse/wetland.
- Monitor weather forecasts and ensure the erosion and sedimentation control devices are maintained and ready for any rainfall events. Keep additional materials, machinery, and equipment on site in order to troubleshoot any issues that may arise.

5.2.3 Large Projects: Erosion and Sedimentation Prevention Plans

Before construction begins, erosion and sediment prevention plans need to be developed, especially for large or more complex projects. Complex projects may involve sites with difficult terrain or sites with soils particularly prone to erosion, such as clay soils.

The plan should be guided by the following approach: site evaluation, erosion control planning incorporated into the work schedule, and sediment prevention and site management.

It is essential to plan and place sediment prevention devices before the construction phase of a watercourse alteration to intercept and trap sediment before it reaches a watercourse/wetland. These devices must remain in place until permanent vegetation has been established or the site is otherwise stabilized.

PREVENTING PROBLEMS

Expose the smallest amount of soil possible for the shortest amount of time.

Retain existing vegetation wherever possible.

Smooth grade any disturbed soil to a uniform slope.

Re-vegetate and/or cover soil where possible.

Divert surface water away from exposed soil.

Maintain low runoff velocities.

Trap sediment before it can cause any damage.

Maintain the onsite erosion and sediment prevention devices.

5.2.4 Planning Considerations

One of the mandates of the New Brunswick Department of Environment and Local Government (DELG) is to avoid sedimentation of watercourses. This requires preventative measures to be taken during the planning and construction phases of the project.

Even small projects that expose soil to rain (and ice/snow melt) can cause erosion and sedimentation to watercourses. For example, soil disturbance from a landscaping

project or the tracks from machinery can be enough to cause sedimentation to a watercourse during the next rain storm. Regardless of the project size, be aware that sedimentation from a project can potentially travel to a neighbouring watercourse.

Construction activities and large earth-moving projects accelerate erosion dramatically, mainly by exposing large areas of soil to rain and running water. If erosion is not prevented and runoff is not properly treated, the result is often severe siltation of nearby watercourses. General design principles must be used for any project.

Runoff is defined as the portion of precipitation on a drainage area that runs along the surface of the ground and is discharged into streams and waterways. Runoff transports suspended sediment and has to be directed away from areas of exposed soil.

The following sections (5.2.5 to 5.2.14) provide techniques on runoff diversion in relation to road building. In most cases, these techniques are installed in conjunction with road construction, not after.

5.2.5 Road Crowning

Road crowning is done by making the center of the road higher than the outer edges. Crowning is used to encourage water to drain into roadside ditches to reduce rutting and the need for road maintenance. The average slope of the crown should be 3%.

5.2.6 Roadside Ditches

Roadside ditches are used to intercept and carry runoff to locations where the concentrated water flow can be safely carried downslope using drainage control structures such as off-take ditches or cross-drainage culverts.

- Where property ownership allows, roadside ditches must end at least 30 metres (100 ft) from watercourses/wetlands and water directed through an off-take ditch. Ditches must never discharge directly into a watercourse/wetland.
- Roadways located on reasonably level ground (low gradient) should have ditches constructed on both sides.
- Roadways located on steep terrains or hillsides should have ditches constructed on only the uphill side to intercept seepage and runoff
- Design roadside ditches to promote proper water flow management as follows:
 - Design the ditch to adequately handle the expected peak flow runoff
 - Maintain a minimum ditch gradient of 2%. Where possible, ditches should maintain the same slope as the roadway.
 - Ditch gradients less than 2% can be effective; however, a more frequent inspection and maintenance regime should be undertaken. Slopes at this level have the potential to pond water, which may saturate the subgrade.
 - Avoid sharp or abrupt changes in the gradient to minimize scouring of the invert of the ditch
 - Extend the ditch beyond areas deemed unsuitable for water dispersal such as sensitive soils, wetlands, or cuts

- Construct roadside ditches in the following manner:
 - Ditches should be constructed in an uphill direction to prevent trapping of surface runoff
 - Excavate ditches to a minimum depth of 30 centimetres (12 in)
 - Ditches should have a curved or flat bottom with fore and backslopes no steeper than a 1.5:1 slope
 - Areas that are prone to erosion should be stabilized immediately after excavation. Minimize ditch erosion using the following techniques:
 - Line the ditch with non-erodible material such as rock or gravel
 - Construct check dams or sediment barriers within the ditch to control water velocity and reduce sedimentation. See Section 5.2.7 *Check Dams* and Section 5.2.8 *Straw/Hay Bale Barriers*. This is a temporary measure until construction is complete, and all exposed areas are stabilized.
 - Construct settling ponds (or traps) at the end of the ditch to check the water velocity. The larger particles of sediment suspended in the runoff settle out in the pond/trap. See Section 5.2.10 *Settling Pond (or Sediment Trap)*.
 - Vegetate the ditch cross-section to reduce erosion.
 - In areas of highly erodible soils, postpone construction activities until such time as the ground is frozen or weather conditions are dry.

5.2.7 Check Dams

Check dams are temporary structures made from stones, hay/straw bales, sandbags, or logs constructed across ditches. Check dams are used to reduce the velocity of the concentrated flow and thereby, the potential for erosion until permanent stabilization of the disturbed area has been established.

Construct a check dam using the following procedure:

- Embed check dams in the bottom and the bank of the ditch by digging a trench at least 25 centimetres (10 in) deep across the width of the ditch. This will help prevent undercutting and runaround.
- Place dam material over the trench area until a height of 20 centimetres (8 in) below the roadbed is reached
- Construct check dams with the center at least 15 centimetres (6 in) lower than the ends of the dam. This notch in the center enables accumulated water to flow over the dam rather than around the ends, while sediment settles out on the upstream side of the dam.
- Stabilize by backfilling and compacting the soil against the dam
- Place check dams between 15 to 200 metres (50 to 670 ft) apart depending on the slope of the ditch. See Figure 5-4.

Inspect check dams regularly and after each runoff event to ensure that sediment does not accumulate to an elevation of more than half of the height of the dam. If this is the case, remove all accumulated sediment and dispose of it in an area where it will not re-enter a watercourse/wetland.

Figure 5-4 Measuring the placement of check dam distance

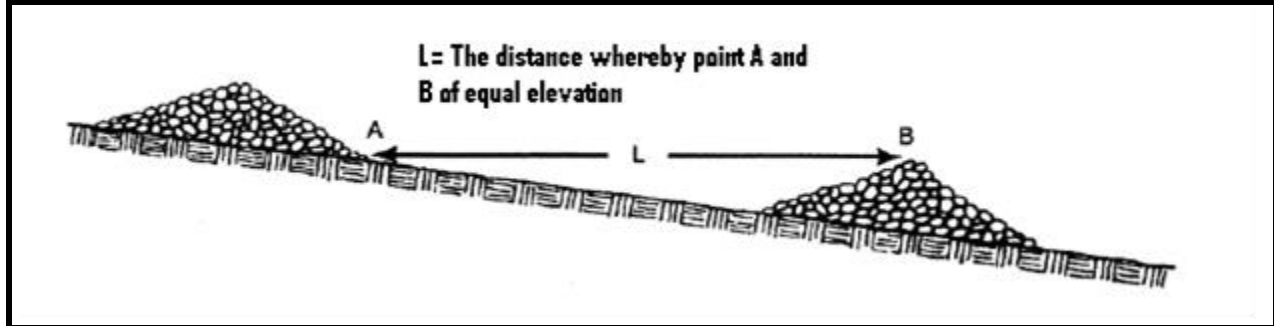

5.2.8 Straw/Hay Bale Barriers

Straw/hay bales and silt fences are temporary structures which function as sediment barriers. These sediment barriers are placed around the downslope perimeter of a disturbed area or along the top of the bank of a watercourse, in order to intercept runoff and trap sediment before it reaches the watercourse. See Figure 5-5.

Figure 5-5 Procedure for constructing a straw bale barrier

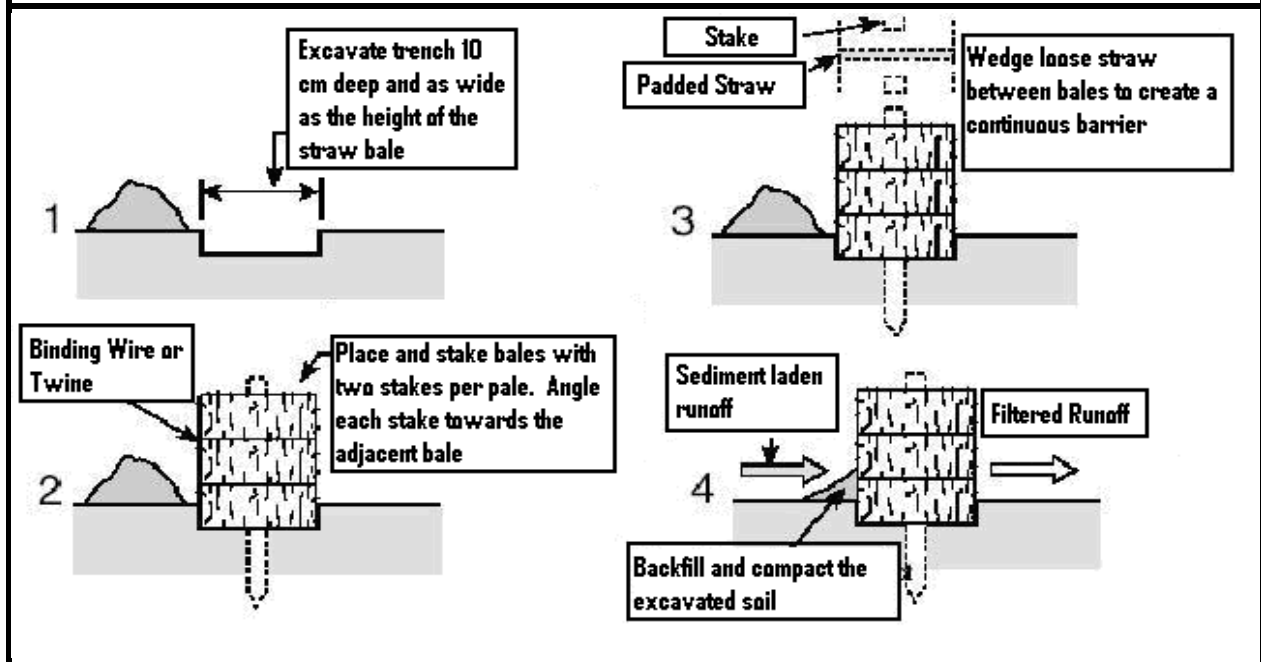

- Sediment barriers must be erected prior to any soil disturbance of the upland area
- The gradient of the upslope of the barrier should be no steeper than 2:1 (horizontal to vertical)
- Sediment barriers should be checked regularly and immediately after each rainfall event for repair or replacement
- On the downhill side, backfill should be built level to the ground

- On the uphill side, build the backfill up approximately 10 centimetres (4 in) above the ground
- Remove the straw/hay bale barrier once the site is stable
- For placement distance, see Figure 5-4

5.2.9 Silt Fence Construction

Construct a silt fence using the following procedure. See Figure 5-6:

- Silt fences should be limited to situations in which only sheet flow or overland flows are expected, not concentrated flow
- Set wooden or steel posts a minimum of 3 metres (10 ft) apart and drive into the ground a minimum of 30 centimetres (12 in). Wooden posts should be 150 centimetre (60 in) in length and at least 10 centimetres (4 in) in diameter.
- Excavate a trench, approximately 15 centimetres (6 in) deep up-slope from and along the line of the post
- Attach filter fabric to the posts on the uphill side and extend into the trench approximately 15 to 20 centimetres (6 to 8 in)
- Fence height should not exceed 90 centimetres (36 in)
- Backfill the trench over the fabric and compact the excavated soil
- Silt fences are designed to remain in place until vegetation has re-established. Once the site is stabilized, they must be removed and properly disposed of.

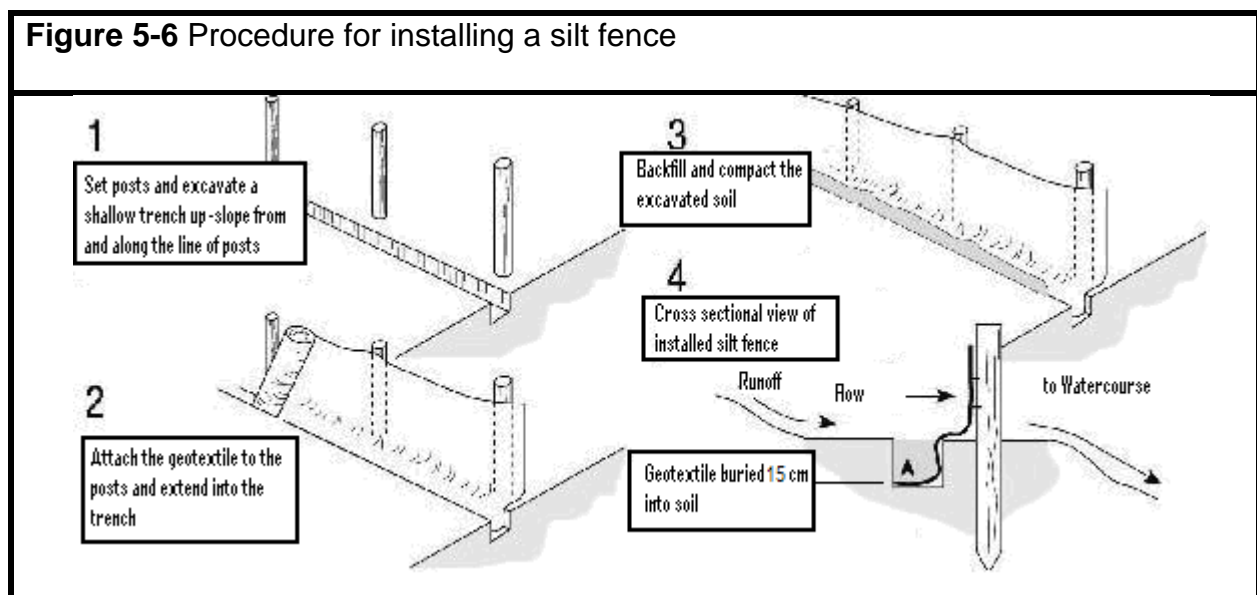

5.2.10 Settling Pond (or Sediment Trap)

Settling ponds or sediment traps are used to intercept and retain sediment-laden runoff. See Figure 5-7. These ponds are usually located at the end of the ditch.

Sediment ponds are most often used when space is limited, or the road gradient is steep.

- Locate settling ponds at least 30 metres (100 ft) from watercourses/wetlands
- Settling ponds must have a volume of at least 190 cubic metres for every hectare (100 yds/acre) of a road under construction
- Construct a settling pond using the following procedure. See Figure 5-7.
 - Excavate the designated area to a minimum depth of 1.2 metre (4 ft) with the average length at least twice the average width
 - Construct the inner sides of the pond at a slope of 4:1
 - Line the outlet of the settling pond with rip-rap to prevent scouring and re-introduction of suspended sediment into the runoff. The area below the outlet should be stable and well-vegetated.
 - Maintain the area to ensure that the elevation of the sediment in the pond is 30 centimetres (12 in) below the lip of the outlet. When sediment accumulates to the lip of the outlet, remove sediment from the pond and dispose to an area where it cannot be washed into a watercourse/wetland by floodwaters or surface runoff

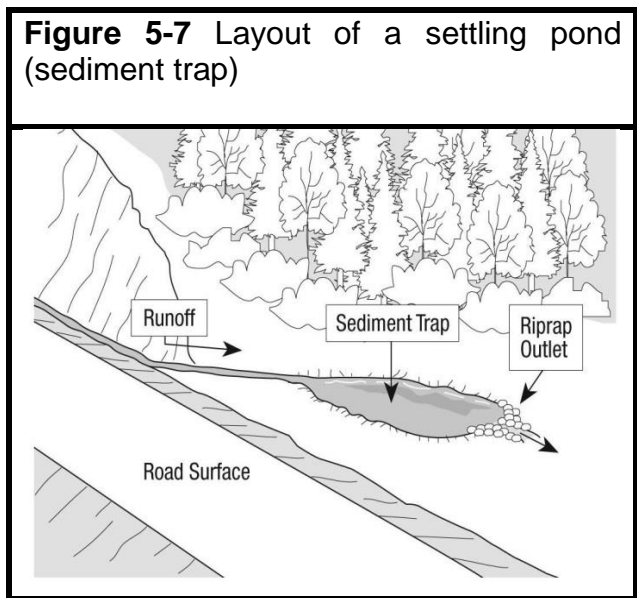

5.2.11 Off-Take Ditches

Off-take ditches are used to transport concentrated runoff into well-vegetated areas in an effort to filter out sediment before runoff enters a watercourse/wetland. When constructing off-take ditches, practice the following:

- Locate off-take ditches at least 30 metres (100 ft) from watercourses/wetlands. If the topography permits, construct an off-take ditch on both sides of the road.
- Space off-take-ditches to accommodate the ditch gradient. See Example 5-1. Use the following formula:

$$\text{Spacing (m)} = \frac{500 \text{ m}}{\% \text{ ditch grade}}$$

$$\text{Spacing (ft)} = \frac{1640 \text{ ft}}{\% \text{ ditch grade}}$$

- Spacing may be disrupted in areas of unsuitable conditions such as bedrock substrate. Where this occurs, use the closest location available and resume construction.
- Extend off-take ditches into well-vegetated areas beyond the treed buffer. A suggested distance is 7.6 metres (25 ft) into the vegetated or wooded area.

5.2.12 Cross-Drainage Culverts

Cross-drainage culverts are used to transport runoff from one side of the road to the other at a road junction or under and away from a roadway. Diverting concentrated runoff to the low side of the road should prevent excessive runoff in ditches, thus reducing erosion of the roadbed and the potential for siltation. Install a cross-drainage culvert using the following procedure:

- Locate cross-drainage culverts at least 30 metres (100 ft) from watercourses/wetlands
- The minimum accepted opening of a cross-drainage culvert is 30 centimetres (12 in)
- If the road is located on a sidehill, ensure a cross-drainage culvert drains runoff to the downhill side of the road
- Space cross-drainage culverts to accommodate the ditch gradient. Use the following formula. This is the same formula as off-take ditches. See Example 5-1.

$$\text{Spacing (m)} = \frac{500 \text{ m}}{\% \text{ ditch grade}}$$

$$\text{Spacing (ft)} = \frac{1640 \text{ ft}}{\% \text{ ditch grade}}$$

EXAMPLE 5-1 CALCULATING OFF-TAKE DITCH SPACING

How far apart should off-take ditches be placed with a ditch gradient of 15%?

$$\begin{aligned} \text{Spacing (m)} &= \frac{500 \text{ m}}{15 \%} \quad \text{or} \quad \frac{1640 \text{ ft}}{15 \%} \\ &= 33 \text{ m} \quad \quad \quad 109 \text{ ft} \end{aligned}$$

The off-take ditches should be spaced 33 metres (109 ft) apart.

- Spacing may be disrupted in areas of unsuitable conditions such as bedrock substrate. Where this occurs, use the closest location available and resume installation of culverts.

- Install cross-drainage culverts at a 30° angle downslope from a line perpendicular to the centerline of the road. See Figure 5-8. This allows water to flow easily through the culvert. Also, install a ditch block or groin to direct water from the ditch into the cross-drainage culvert.

5.2.13 Temporary Mulching

Daily maintenance of exposed soil must be practiced when construction lasts more than one day. To stabilize exposed soil at the end of each day:

- Spread mulch evenly over exposed erodible areas. Types of mulch to use include hay, straw, bark, natural vegetation, or mulch from waste-resource material.
- Hay or straw mulch is typically applied at a rate of one bale per 25 square metres (270 sq ft)
- Or place temporary matting such as erosion control blankets over the disturbed area

5.2.14 Permanent Re-Vegetation

Re-vegetation is a long-term surface water control method. Permanent re-vegetation of disturbed areas in and around the worksite should be done immediately following project completion.

- Prepare the site by:
 - Using effective erosion and sediment control techniques where needed
 - Grading the disturbed area at a uniform slope
 - Removing stones or debris
 - Loosening the soil by hand raking
 - Fertilizing where necessary
- Plant during suitable temperature and moisture conditions to promote plant growth. If planting after September 1st, soils will require a dense layer of mulch.
- Use mulch to improve the odds of successful re-vegetation as it conserves moisture, modifies soil temperatures, and prevents soil compaction.
- Choose a low maintenance seed mixture that is adapted to the local climate and soil conditions. Choose fast-growing and easy-to-plant mixtures. Vegetation must be native perennial non-invasive species.

Figure 5-8 Installation of a cross-drainage culvert

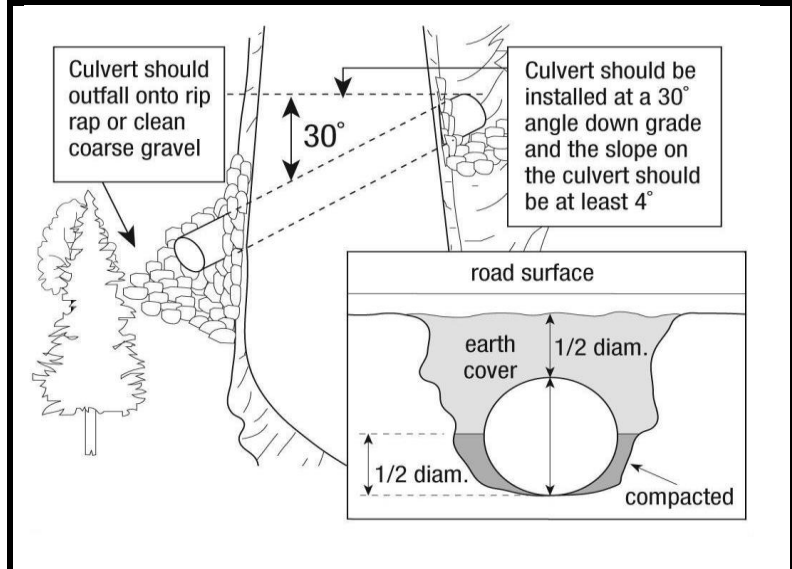

- If possible, spray hydroseed over the disturbed soil area. This mixture is comprised of a slurry of seed, fertilizer, wood fibre mulch, and water that take hold quickly and effectively.
- Maintain the area by watering and fertilizing (where necessary).

5.3 MAINTENANCE OF MACHINERY AND PETROLEUM MANAGEMENT

Accidental release of pollutants can have detrimental consequences on the aquatic environment. Vehicle and machinery maintenance, in addition to proper storage, handling and transfer of fuels/lubricants, may reduce the potential for accidental spills or discharges into the environment. As a precautionary measure, action plans must always be in effect.

5.3.1 Machinery and Equipment

Machinery and equipment should be regularly maintained to prevent leaks of hydraulic fluids, cooling system liquids, and other fluids. Machinery and equipment should be inspected for leaks regularly.

Fuel in a secure area away from watercourses/wetlands or anywhere that surface water could become contaminated.

A fire extinguisher suited for extinguishing fires ignited by fuels should be on site at all times.

Machinery and equipment must never be cleaned in or near a watercourse/wetland. This is not limited to the alteration site, but anywhere that surface water could become contaminated and seep into a watercourse, wetland, or groundwater. Machinery should be washed in a designated maintenance area.

5.3.2 Fuel Handling and Transfer

All fuelling, maintenance, or repair of machinery and equipment should be performed at least 30 metres (100 ft) from watercourses/wetlands.

When servicing machinery and equipment, dispose of all containers, cartridges, filters, used oil and other refuse at a recognized disposal site in accordance with DELG.

5.3.3 Clean-up Material

Keep spill clean-up kits on site at all times. These kits are designed specifically for the various types of hazardous products that may be used. Each kit often designates a limit for the maximum quantity of spilled product that the kit can absorb/contain. Certified installers must ensure that all machinery on site is equipped with its own spill kit and that each spill kit is sized appropriately in order to accommodate an incidental release.

Keep sorbent materials, suited to contain and/or absorb spilled products, on site at all times.

Acceptable sorbent materials include soil, sand, and commercially available spill control products.

5.3.4 Storage

All petroleum storage tank systems must be in compliance with the [**Petroleum Product Storage and Handling Regulation – Clean Environment Act**](#) (New Brunswick Regulation 87-97). Storage tank systems with a total capacity of greater than 2000 litres must be registered.

Store all petroleum products/lubricants and other hazardous materials at least 30 metres (100 ft) from watercourses/wetlands. The storage area must also be outside the floodplain.

Ensure that fuel storage containers, drums, and tanks are in good condition and clearly marked. Storage tanks must be inspected regularly as per Section 65 of the [**Petroleum Product Storage and Handling Regulation**](#).

Locate storage tanks on impervious mats and surround them by an impervious dyke/container.

The dyke area should be sized to accommodate a spill quantity of at least 110% of the storage tank capacity, with an additional 150 millimetres (6 in) freeboard.

5.3.5 Reporting Procedures

Any spill, regardless of quantity, must be reported by contacting DELG during business hours or the National Environmental Emergencies Center (1-800-565-1633) after hours.

The reporting procedure must contain the following information, as stated in the [**Water Quality Regulation**](#) (82-126, Section 11(2)), under the authority of New Brunswick's [**Clean Environment Act**](#), C-6.

- The spilled product(s) type and amount
- The area affected including potential watercourse(s)/wetland(s)
- The cause of the spill
- The remedial action taken or to be taken

5.3.6 Containment

If safe to do so, to the greatest extent possible, stop the leak/spill immediately, secure the area where the spill occurred and contain the spilled product.

5.3.7 Clean-up Procedures

It is the responsibility of the certified installer to ensure the area affected by the spill is cleaned up to the satisfaction of DELG.

- When clean-up poses a safety threat, wait for expert help to arrive.
- If clean-up can be done safely, apply the following techniques.
 - When a small spill occurs on level land, use spill clean-up kits and sorbent material to clean up/absorb the spill. Excavate all affected soil and place it in a temporary container.
 - When possible, pool spill product and pump it into a temporary container. Excavate all affected soil and place in a temporary container.
 - When a spill occurs on a side hill or slope, construct a berm of impermeable soil downhill from the spill area to intercept the spilled product(s). Excavate all affected soil and temporarily place it in a container.
 - Dispose of sorbent material and contaminated soil at a recognized disposal site. A list of disposal sites may be obtained from DELG.
- If spill product(s) reaches a watercourse, or the open water of a wetland, attempt to prevent the material from migrating by using the following:
 - On small watercourses, use a weir made of plywood, sheets, logs, or any other available material. Place the weir across the watercourse, allowing water to flow underneath while stemming the movement of the floating oil/contaminant.
 - On larger watercourses (1 metre (3ft) deep or greater), a fence-type structure may be used. Stake and brace snow fencing in the watercourse. Line the upstream side of the fence with commercially available floating booms (adsorbent pads).
 - Sorbent booms may be used alone to intercept spill products by installing the boom across the full width of the watercourse. These booms may be either commercially purchased or fabricated on-site.

5.4 MATERIALS USED IN AND NEAR WATERCOURSES AND WETLANDS

Only materials that will not negatively impact water quality may be used in watercourses/wetlands or in close proximity to watercourses/wetlands.

5.4.1 Fresh Concrete

Fresh, wet, and uncured concrete must not come into contact with stream flow in the watercourse or in contact with water that will flow into a watercourse as it can be toxic to aquatic life.

- Concrete blocks must be cured for at least one week before they are used in or near a watercourse/wetland.
- Concrete used in a watercourse that has been isolated from stream flow must be permitted to cure long enough prior to releasing stream flow so that it does not contaminate the water after the flow is released. Concrete must be cured for at least one week before coming into contact with stream flow.
- Excess, unused concrete must not be permitted to enter a watercourse/wetland.
- Wash water contaminated with concrete must not enter a watercourse/wetland.

5.4.2 Treated Wood

Care should be taken when choosing treated wood (wood containing preservatives) for use near watercourses/wetlands.

- The use of wood treated with creosote is not permitted for use in any part of the structure, nor repair of any existing structures. This includes decking and stringers of a bridge.
- The following wood materials can be used below the ordinary high water mark of a watercourse and in a wetland:
 - untreated rot-resistant timber, such as hemlock, tamarack, juniper, or cedar;
 - pressure-treated Alkaline Copper Quaternary (ACQ), or Chromated Copper Arsenate (CCA) treated wood if treated in accordance with CAN/CSA-O80 SERIES-08 (R2012) and as described in the Wood Preservation Specification Guide (Ottawa, ON. Wood Preservation Canada, 2014) as updated from time to time. For more information, visit:
<http://www.woodpreservation.ca/index.php/en/specifiers-guide>

Note: It is recommended to avoid the use of wood pressure-treated with chromated copper arsenate (CCA) (*i.e.* wolmanized) below the ordinary high water mark of watercourses and in a wetland.

WHY RISK IT

Follow the requirements for drying and curing time of pressure-treated wood and concrete to reduce the potential for serious water quality problems.

Remember, a rainfall event can happen at any time. Runoff over or interfacing with construction materials can carry toxic substances into the watercourse/wetland.

5.4.3 Rock Material

Rock material used in a wetland or within 30 metres of a watercourse/wetland must be clean coarse granular aggregate material, durable, non-ore-bearing, non-watercourse/wetland derived and non-toxic to aquatic life.

In some cases, there may be a requirement for a mixture of rock with a percentage of fines (20% with no clay) when constructing an energy dissipation pool for culvert installations or a new watercourse channel. The rock mixture is to be washed thoroughly prior to releasing the stream flow into the energy dissipation pool or channel.

Rock must not be sulphide bearing aggregate. Some rock, commonly referred to as slate or shale, can be sulphide bearing and can generate acid if disturbed and exposed to air/water. Slate and shale rock can be tested to determine its acid-producing potential.

5.5 SITE CLEAN-UP

Remove all material from the site upon completion of the project. Excavated materials must be disposed of where they cannot be washed into a watercourse/wetland by floodwaters or surface runoff. Other materials, which may include excavated soil, wood debris, excess rip-rap, etc., must be entirely collected and disposed of outside a regulated area, in a manner acceptable to DELG. A good clean-up results in the site being returned as close as possible to its original condition.

MODULE 6: CULVERT INSTALLATION TIER REVIEW APPROACH

TIER 1 (5-day review)

- **Replacing closed-bottom culverts** (0-0.5% stream slope, max length 30 m, max drainage area 20 km²)
- **Replacing closed-bottom culverts with twin pipes** (0-0.5% stream slope, max length 30 m, max drainage area 20 km²)
- **Removing (decommissioning) closed-bottom culverts**

TIER 2 (15-day review)

- **New closed-bottom culverts** (0-0.5% stream slope, max length 25 m, max drainage area 20 km²)
- **All closed bottom culverts with baffles** (0.51-5% stream slope, max length 25 m (30 m for replacements), max drainage area 20 km²)
- **Replacing an open-bottom culvert or a bridge with a closed-bottom culvert** (0-5%, max length 30 m, max drainage area 20 km²)
- **Stream simulation culverts** (0-6%, max drainage area 20 km²)

TIER 3 (requires a standard WAWA permit)

- Any crossing not sized for the 1 in 100-year flood event
- Any closed-bottom culvert that does not provide fish passage
- Installation of multiple (more than two pipe) closed-bottom culverts
- Any alterations resulting in a permanent wetland impact greater than 100 sq. m
- Any alterations in and within 30 m of a provincially significant wetland (PSW)
- Any alterations within a designated [watershed](#) or [wellfield](#) used as a source for public water supply
- Installing or replacing a closed-bottom culvert where there is an aquatic species (or habitat) at risk under the [Species at Risk Act](#)
- Any other activity not approved under Tiers 1 and 2 or exceeding the guidelines

6.0 CULVERT INSTALLATION

The installation/construction of a watercourse crossing should have minimal impact on the stream flow, maintain natural stream morphology, preserve fish habitat, and provide fish passage.

When installed properly, culverts are an acceptable option for a permanent watercourse crossing.

6.1 BASIC STANDARDS

Under the Watercourse Alteration Certification Program, the following applies to culvert installations and must be strictly adhered to:

- Closed-bottom culverts must allow fish passage. Closed-bottom culverts without fish passage provisions (*i.e.* baffles) are only installed when the stream slope is $\leq 0.5\%$ or the difference in elevation between the control riffles is 0.2 metres (8 in) or less, and the riffle to riffle distance is 40 metres (131 ft) or less. The maximum slope of a culvert installed under the Watercourse Alteration Certification Program is 5.0%. A properly installed culvert requires the invert of the culvert to be embedded 0.2 times of the culvert diameter (0.2D) or 0.45 metre (18 in), whichever is less. See Section 6.3.1 *Watercourse Gradient/Slope and Fish Passage*.
- A properly sized culvert must have the capacity to accommodate a 1 in 100-year runoff event. This does not mean it will occur only once in every 100 years. It means that there is a one percent probability of such an event occurring in any given year.
- Energy dissipation pools must be constructed at the outlet of all closed-bottom culverts where the stream slope is greater than 0.5%.
- All instream (*i.e.* below the bankfull width of a watercourse, whether wetted or not) work must be carried out in isolation of the stream flow.

Note: Although a certified installer may carry out the installation of culverts (provided a Watercourse and Wetland Alteration (WAWA) permit has been obtained for the work), under the Watercourse Alteration Certification Program, the submission for the WAWA permit for watercourse crossings requiring designs and drainage area calculations can only be submitted by a certified designer.

6.2 TYPES OF CULVERTS

A culvert is defined as a metal, concrete, or plastic structure that conveys water under a roadway whereby the top of the cover material is graded to form the travel surface.

The following provides information on the types of culverts available and their potential impacts on the aquatic environment. These culverts are listed from best to worst from a fish and fish habitat perspective.

Open-bottom culverts are similar to bridges. These culverts are founded on various types of footing support structures and can be made from steel, plastic, or concrete. See Figure 6-1.

Advantages:

- Maintain the natural stream bed and stream gradient
- Pass all fish and other aquatic organisms
- Can better withstand flood events
- Less likely to be obstructed by beavers
- Less susceptible to corrosion

Disadvantages:

- Improper installation could result in scouring and erosion. See Module 7 *Installation of an Open-Bottom Culvert and Bridge Construction* for guidelines.
- The design, construction, maintenance is more complex
- The duration of construction is significantly increased over a closed-bottom culvert

Box culverts are similar to pipe arches. These culverts are useful in areas where the height of cover is limited as they require little cover material. They can be made from wood or concrete. See Figure 6-2.

Advantages:

- Help maintain the natural channel width

Disadvantages:

- The wide, flat bottom may result in reduced water depth, potentially limiting fish passage

Pipe arch culverts are closed-bottom structures shaped such that the span is greater than the rise with a slightly convex bottom. They are made from steel or concrete. See Figure 6-3.

Advantages:

- Help retain the natural substrate in the culvert
- Useful in areas where the height of cover is a limiting factor

Figure 6-1 Open-bottom culvert

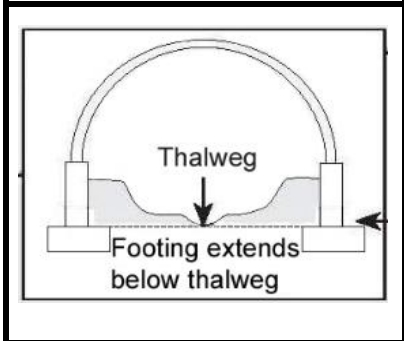

Figure 6-2 Box culvert

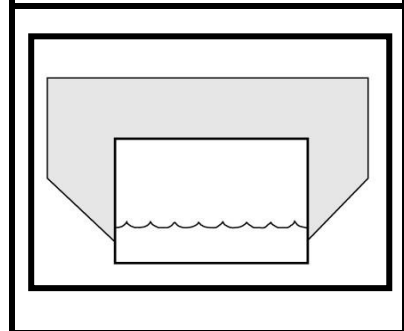
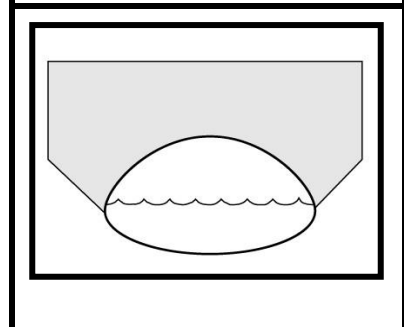

Figure 6-3 Pipe arch culvert



Disadvantages:

- The wide, slightly convex bottom may result in reduced water depth, potentially limiting fish passage

Multiple culverts are often used to pass high water flows in areas susceptible to flooding. A maximum of two culverts may be used at any given crossing. They are made from steel, concrete, or plastic. See Figure 6-4.

Figure 6-4 Multiple culvert

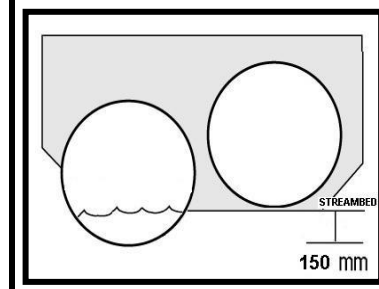

Advantages:

- Can be used where the road elevation is limited

Disadvantages:

- Are susceptible to ice or debris blockage obstructing fish migration and flooding upstream areas
- Require more work for proper installation and stabilization

Circular culverts are the most commonly used but can have the greatest impact on the fish and fish habitat. They are made from aluminum, aluminized type 2 CSP, concrete, or plastic. See Figure 6-5.

Figure 6-5 Circular culvert

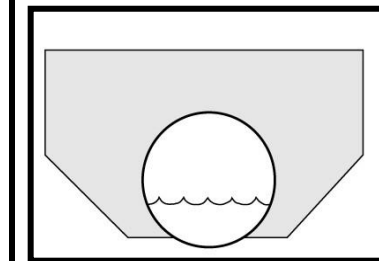

Advantages:

- Economical
- The quickest and easiest type to install

Disadvantages:

- Reduces the cross-sectional area of the channel, potentially increasing water velocity. This may disrupt fish migration, undermine the inlet or scour the stream bed at the outlet.
- They may require fish baffles to accommodate fish passage. Baffles will add cost and maintenance to the pipe. In addition, it will reduce the opening, which may result in an increase of diameter required to pass the stream flow.
- They are susceptible to ice or debris blockage obstructing fish migration and flooding upstream areas.

6.3 CULVERT SIZING

Proper culvert sizing promotes fish passage and minimizes changes to the aquatic habitat and water flow. An undersized culvert may result in a complete washout of the culvert or increased water velocity through the pipe creating a barrier to fish passage and causing scouring at the outlet.

A properly sized culvert must have the capacity to accommodate a 1 in 100-year runoff event. This does not mean it will occur only once in every 100 years. It means that there is a one percent probability of such an event occurring in any given year.

Under the Watercourse Alteration Certification Program, sizing of culverts must be carried out by a certified designer.

6.4 FISH PASSAGE

When installing closed-bottom culverts, there are limitations on the watercourse slope to provide fish passage.

Slope is a crucial watercourse feature that is highly responsible for indicating the level of water velocity at any given point in a stream. The installation of closed-bottom culverts within high sloped watercourses has been known to create fish passage issues.

Given how vital slope is when considering the installation of a closed-bottom culvert, knowing how to measure it properly is extremely important.

During the planning stage of a watercourse crossing installation, it is important to consider how fish passage will be provided through all stages of the project. As a certified installer, it is also important to understand how to determine the slope of a watercourse to ensure that the culvert is being properly installed.

6.4.1 Watercourse Gradient/Slope and Fish Passage

The watercourse gradient/slope is determined by the difference in elevation between the first riffle upstream of the inlet of the culvert and the first riffle located at least three culvert diameters downstream of the outlet of the culvert, divided by the distance between these riffles. See Figure 6-6.

A closed-bottom culvert will pass fish when (a) the riffle to riffle slope is 0.5% or less or (b) the difference in elevation between the riffles is 0.2 metre (8 in) or less and the riffle to riffle distance is 40 metres (131 ft) or less. See Figure 6-7(a)+(b).

When the gradient of the stream bed is less than 0.5%, the culvert must be embedded 0.2 times the culvert diameter (0.2D) or 0.45 metre (18 in), whichever is less, below the bed of the watercourse at the proposed inlet and outlet locations. See Figure 6-7(a).

Figure 6-6 Determining the stream gradient

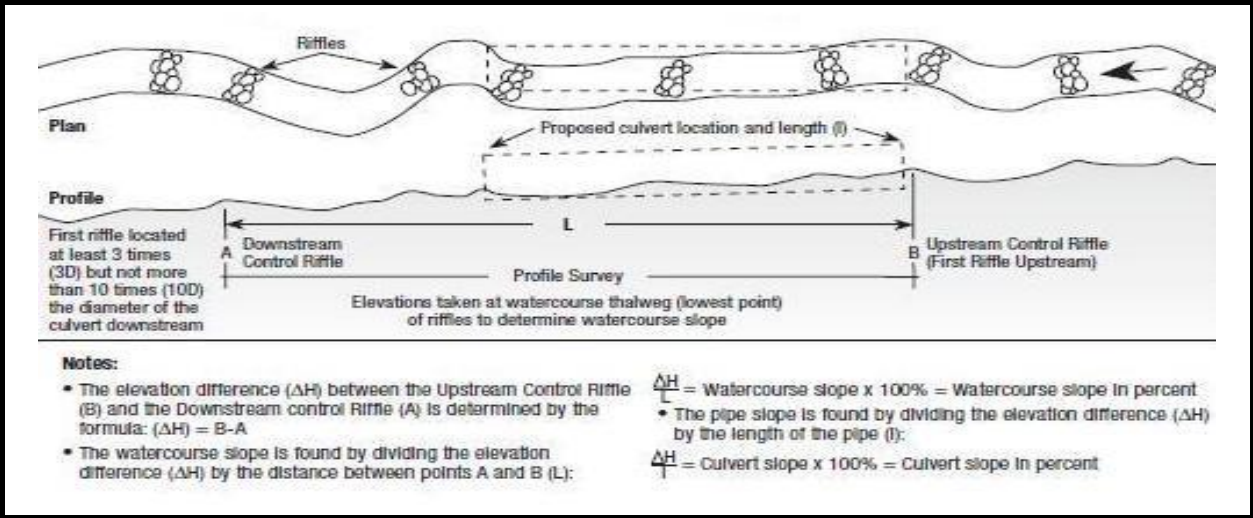

When the distance between the first riffle upstream of the inlet of the culvert and the first riffle located at least three culvert diameters downstream of the outlet is 40 metres (131 ft) or less, and the difference in elevation between the thalweg of these riffles is 0.2 metre (8 in) or less, the ends of the culvert must be embedded 0.2 times the culvert diameter (0.2D) or 0.45 metre (18 in), whichever is less, below the elevation of the thalweg of the corresponding riffle. See Figure 6-7(b).

Figure 6-7(a)+(b) Culvert installation when fish baffles are not required

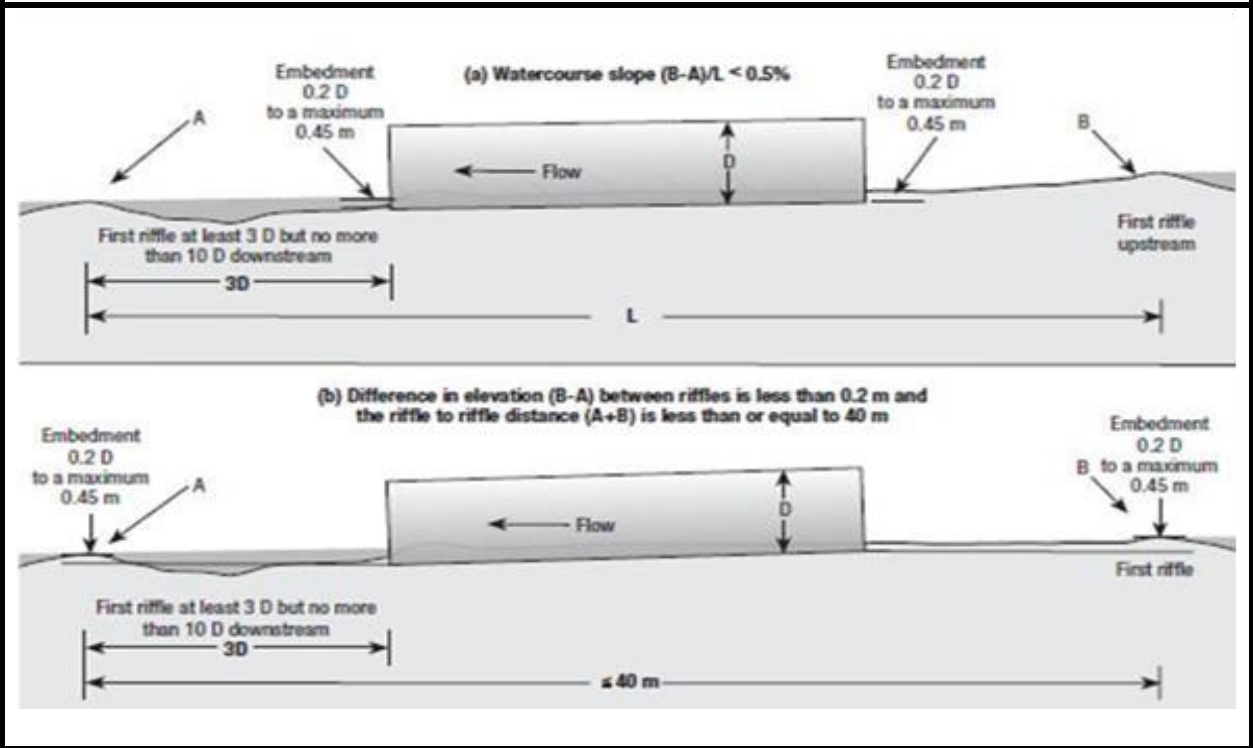

6.4.2 Calculating Watercourse Gradient/Slope

Surveying a watercourse allows individuals to document and capture all of the watercourse features and record the precise slope within their proposed work space. See Figure 6-8.

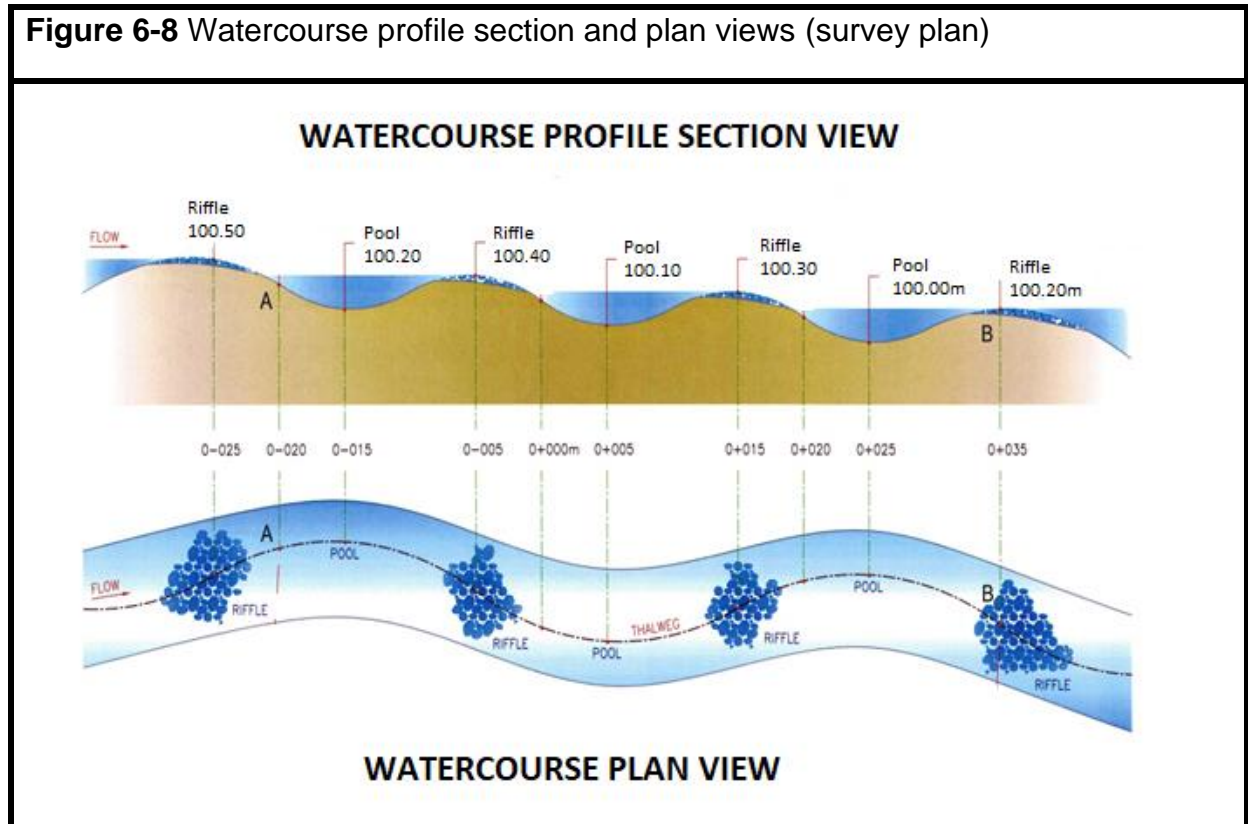

When elevations from the survey are all displayed in a watercourse profile/plan diagram as shown in Figure 6-12, designers can visually display how their proposed culvert is going to fit and what riffles will be utilized for the stream slope calculation. The formula for calculating watercourse slope is:

$$\text{Slope} = ((\text{Stream Elevation Difference}) / \text{Length}) \times 100$$

$$\text{Slope} = ((B - A) / L) \times 100$$

See Example 6-1.

EXAMPLE 6-1 CALCULATING WATERCOURSE SLOPE/GRADIENT (IN PERCENTAGE)

$$\text{Slope} = ((\text{Watercourse Elevation Difference}) / \text{Length}) \times 100$$

$$\text{Slope} = ((B - A) / L) \times 100$$

Where:

A = 100.2 m - the elevation of the thalweg at the natural undisturbed downstream control riffle

B = 100.35 m - the elevation of the thalweg at the natural undisturbed upstream control riffle

Length (L) = 55 m

$$\text{Therefore: } = ((100.35 \text{ m} - 100.2 \text{ m}) / 55 \text{ m}) \times 100 = 0.27 \%$$

The watercourse gradient/slope is 0.27%.

Once the stream gradient is confirmed and diameter has been sized, utilize the survey diagram (see Figure 6-8) and the existing site conditions drawing (see Figure 4-8) to develop a cross-section drawing. See Figure 6-9.

Note: Plan to leave room for the addition of a dissipation pool or an extension of the existing one.

In replacement sites, it is very common to have a much larger footprint than what was previously there. This will inevitably mean a new realignment of the site to match up with the existing stream conditions. A well-drawn “existing site” drawing will allow designers to see where the new culvert is going to tie-in.

Figure 6-9 Typical cross-section

<p>NOTES</p> <p><u>Riffle:</u> Shallow water extending across the bed of a flowing watercourse with rapid current and surface flow broken into waves by submerged obstructions such as gravel and cobble.</p> <p><u>Downstream Riffle:</u> Look for the location of the highest streambed elevation between 3-D and 10-D downstream. Take the elevation of the bottom of the wet width channel at this point. (Thalweg)</p> <p><u>Upstream Riffle :</u> Look for the location of the highest streambed elevation within 10-D upstream. Take the elevation of the bottom of the wet width channel at this point. (Thalweg)</p>	
<p>UPSTREAM</p> <p>Invert Elevation C = _____ m</p> <p>Riffle Elevation A = _____ m</p> <p>First Riffle Upstream</p>	<p>DOWNSTREAM</p> <p>Invert Elevation E = _____ m</p> <p>Riffle Elevation B = _____ m</p> <p>First Riffle Downstream</p>
<p>WATERCOURSE SLOPE</p> <p>(A) _____ m - (B) _____ m RISE = _____ m</p> <p>RISE = _____ m</p>	<p>PIPE STRUCTURE SLOPE</p> <p>(C) _____ m - (E) _____ m RISE = _____ m</p> <p>RISE = _____ m</p>
<p style="text-align: center;">RISE = _____ m X 100 = _____ %</p>	
<p style="text-align: center;">RISE = _____ m X 100 = _____ %</p>	
<p>EXISTING CONDITIONS</p> <p>Project Name : _____</p> <p>Location : _____</p>	
<p>Collected by : _____ Date : _____</p> <p>Route No. : _____ Asset No. : _____ File No. : _____</p> <p>District Office : _____ Drawing No. : _____</p>	

6.5 MULTIPLE CULVERTS

The guidelines for installing multiple culverts are as follows:

- A maximum of two culverts may be installed.
- One culvert must be located in the thalweg of the channel with the ends embedded below the thalweg of the upstream and downstream riffles and the inlet invert (bottom) of the second culvert must be set at least 150 millimetres (6 in) higher than control riffles so that during low flow conditions, all the water will flow through the lower culvert. See Figure 6-10. If this is not feasible, the overflow culvert must be designed with a blind weir (baffle without a notch) installed at least 300 mm in height at the upstream end of the pipe.
- Culverts must be placed a minimum of 1 metre (3 ft) or 0.5D apart, whichever is greater, such that a compacter can fit between the pipes to allow for proper compaction.

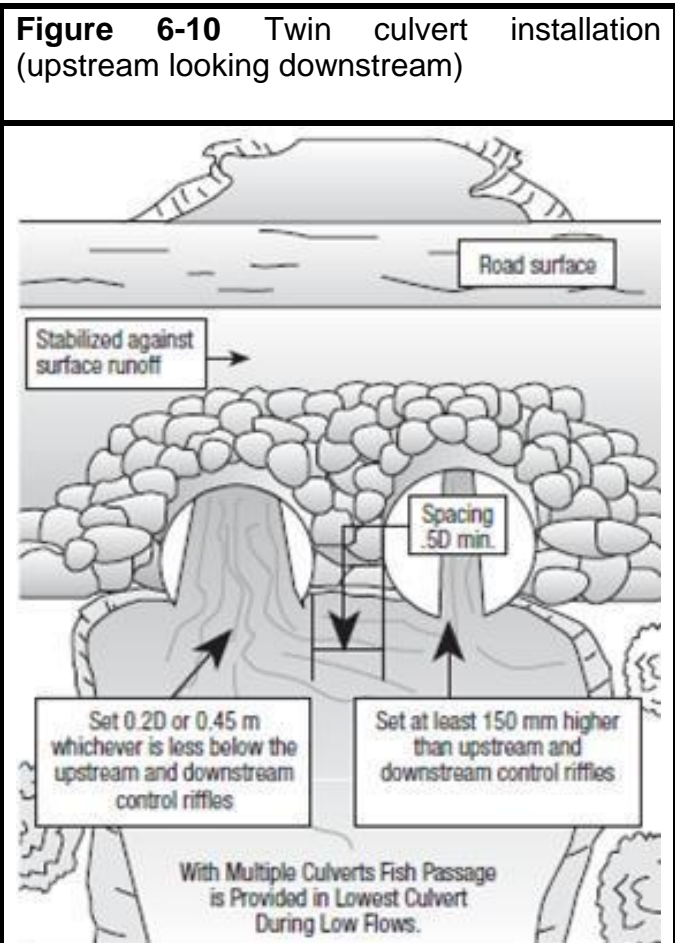

6.6 TIMING OF INSTALLATION

All culvert installations must be carried out between June 1st and September 30th of the same year, preferably during low water conditions. Construction should proceed diligently to help minimize any unnecessary environmental problems and minimize impacts to fish.

Note: Longer projects benefit from water-control methods which provide fish passage (e.g. a diversion channel).

Work and project extensions outside of this window will not be approved through the Watercourse Alteration Certification Program. If there are unforeseen issues that prevent the project from being completed prior to the September 30th deadline, DELG should be contacted as soon as possible to discuss next steps.

6.7 CLOSED-BOTTOM CULVERT INSTALLATION

The steps for installing a culvert have been separated into the following categories:

- General Practices
- Working in Isolation of the Stream Flow
- Installation
- Backfilling
- Stabilization
- Road Approaches

6.7.1 General Practices

The following must be followed when using machinery in or near a watercourse.

- A backhoe or an excavator must be used to prepare a firm bed for the placement of the structure
- All work must be carried out with machinery stationed outside the wetted portion of the channel (fording is not permitted)
- Machinery must be in good working order and must not be leaking any fuel, lubricants, or hydraulic fluid and must be cleaned/degreased to prevent any deleterious substance from contaminating the wetland and to help minimize the spread of invasive plant species
- Machinery must not be washed/refueled in or near a watercourse/wetland; this practice is not limited to the crossing site but anywhere that contaminated overland runoff seeps or drains into a watercourse/wetland

Prior to the culvert being installed, if machinery must cross the watercourse, it must do so using a temporary structure or portable bridge that completely spans the channel in order to minimize the potential for erosion and sedimentation. See Section 7.10 *Temporary Bridges* for the associated guidelines. Machinery must not ford a watercourse at any time during the installation, replacement, or maintenance of a watercourse crossing.

Clearing and grubbing activities within 30 metres (100 ft) of the watercourse must be limited to the footprint on the approaches and the roadside ditches (if included). Clearing activities may occur prior to June 1st (to avoid the nesting season) if all other applicable federal and provincial requirements are met. Grubbing shall not take place until construction of the crossing is ready to begin.

6.7.2 Working in Isolation of the Stream Flow

All activities in the wetted footprint of the channel must be carried out in isolation of the stream flow.

When working in a watercourse, it is necessary to isolate the work site from the stream flow to reduce the impact of silt and fine particulate matter on fish and their habitat. Effective techniques of water control include using cofferdams in combination with a pump-around system and temporary diversion channels.

Use the appropriate water control method prior to any culvert installation. Consider the settings, such as valley slope, height of stream banks, stream gradient, and stream flow when making this decision.

See Section 5.1 *Water Control Measures when Working in a Watercourse (How to Work in Isolation of Stream Flow)* for more details.

6.7.3 Installation

Culvert installation will differ depending on the type of stream bed. Use the appropriate method as described in the following.

Stream Bed Foundation

Install culverts on a firm and uniform stream bed to provide adequate support and to prevent sagging. The natural stream bed may be either firm or soft, and the bed for the culvert should be prepared using the appropriate guidelines such that the natural slope and elevation of the stream bed is maintained.

Soft Stream Bed

- Where the stream bed is soft, excavate to firm ground (up to a maximum of 600 mm (24 in)) and replace with enough clean gravel on a layer of biaxial geogrid to bring the stream bed back up to the level at which the invert of the culvert is to be placed.
- Excavation of the stream bed should be kept to the footprint of the reach of channel the culvert is going to occupy.

Firm Stream Bed

- If the stream bed is firm, excavate the footprint of the reach of channel the culvert is going to occupy to the proper embedment depth below the thalweg of the control riffles.

Stream Bed Rock Size and Impermeability

The substrate in new channels or culvert approaches should be a mix consisting of rock that mimics what is present naturally in the watercourse. Large rocks may cause fish passage issues and in cases where a large size class of rock is needed to reduce erosion then it should be buried below stream bed elevation with and topped with appropriately sized impermeable substrate at least 200 mm (8 in) thick.

The new stream bed mix should have a wide range of particle sizes and must include enough silts and fines (particles less than 2 mm in diameter) to fill interstitial spaces and create an impermeable surface. Fines should be washed into the stream bed with a hose until the water runs clear. If subsurface flow is still evident then more fines and washing may be required.

Small particle sizes are of critical importance for stream bed mixes as a lack of these fines can cause water to flow below the surface of the new channel. It should never be assumed that sediment will be transported from upstream to plug the stream bed as this process could take years.

Placement of Culvert

Place culverts on a uniform slope with the culvert invert (bottom) embedded 0.2D, up to a maximum of 0.45 metre (18 in), below the thalweg of both the upstream and downstream control riffle, as described in Section 6.4 *Fish Passage*. This helps ensure that there will be water inside the culvert during low flow conditions. See Figure 6-7.

Align the culvert as closely as possible with the natural channel. The realignment of a stream beyond the upstream and downstream control riffles (see Section 6.4 *Fish Passage*) is not permitted under the Watercourse Alteration Certification Program. In addition, the control riffles must not be altered in any way. If this criterion cannot be met, an application for a standard watercourse and wetland alteration permit must be made using the [online application program](#).

Unless headwalls are used, the culvert must extend a minimum of 0.3 metre (1 ft) beyond the upstream and downstream toe of the rip-rapped foreslopes developed around the structure.

The foreslopes the rip-rap is to be placed on must be no steeper than 1.5 horizontal to 1 vertical and the minimum thickness of the layer of rip-rap must be 1.33 times the maximum rock size used.

Before the culvert begins to convey the stream flow, rip-rap (or headwalls and wingwalls) must be placed at both ends of the culvert to an elevation of at least half the culvert diameter (rise) above the top of the pipe and a minimum of one pipe diameter (span) on each side of the culvert. See Figure 6-9 for general culvert installation guidelines.

Figure 6-11 Guidelines required for culvert installation

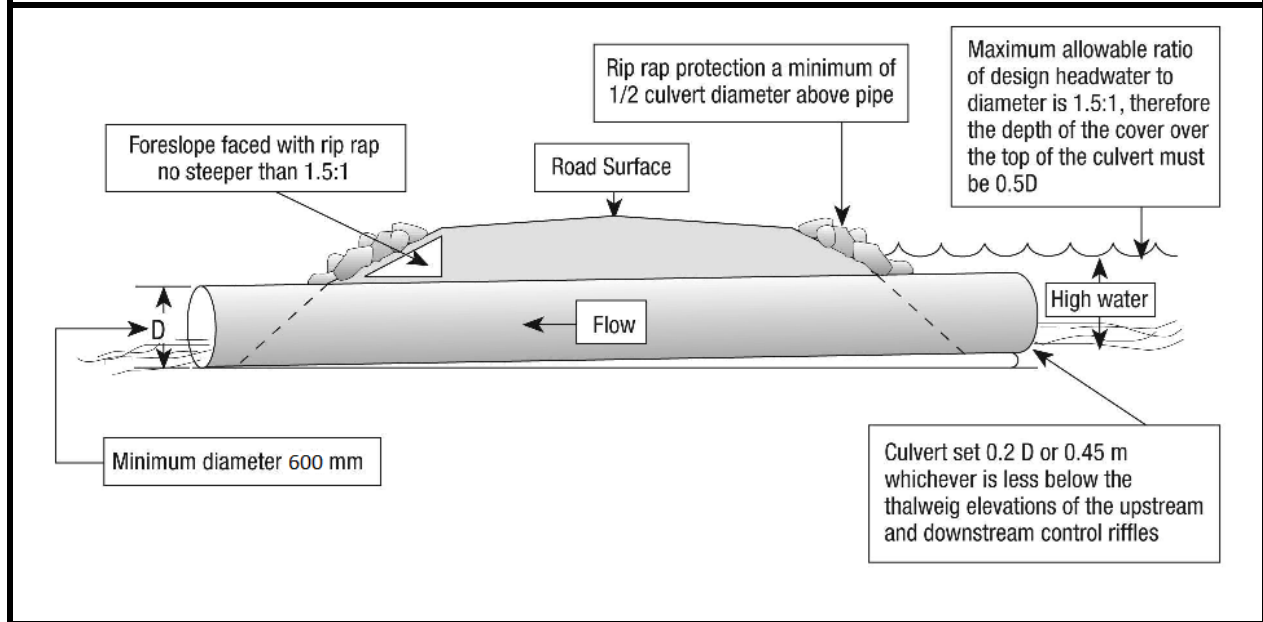

Note: If using a headwater depth to diameter ratio of 1:1 or less, then utilizing half the culvert diameter as the minimum requirement for depth of cover is not required. In this case, use the manufacturer's guidelines.

6.7.4 Backfilling

Once the culvert has been placed on a firm bed at the proper depth below the control riffles, begin the process of backfilling. When properly placed, backfill should equalize the support to both sides of the culvert. The backfill must be compacted sufficiently to prevent culvert shifting and washouts. The following guidelines should be followed.

- **Backfill material**
 - Ideally, aggregate should be sourced from a quarry. Backfill must be composed of clean, well-graded, pit run gravel less than 5 centimetres (2 in) in diameter, or coarse granular sand.
 - Backfill material should not consist of mud, fine sand, or silt as these soils may contribute to culvert washouts and downstream sedimentation.
- **Backfill machinery**
 - Backfill must be placed around and over a culvert with an excavator or backhoe.
 - Compaction can be achieved using hand tampers or machinery such as tamping rollers or vibrating compactors.
- **Backfill placement.** See Figure 6-10.
 - Compact backfill evenly on both sides in 10 to 15 centimetres (4 to 6 in) thick layers. Balance the layers on both sides to prevent the culvert from being

deflected out of shape. This will help prevent any shifting or lifting of the culvert and ensure that there are no voids or soft spots in the backfill material.

- Compact the backfill by hand up to the haunches of the culvert. When compacting below the haunches, do not force backfill under the culvert.
- Cover material must be placed to a minimum height of half the culvert diameter/rise above the pipe.

Note: Before backfilling begins, ensure that adequate room is left for the 0.3 metre (1 ft) extension and the thickness of the rip-rap.

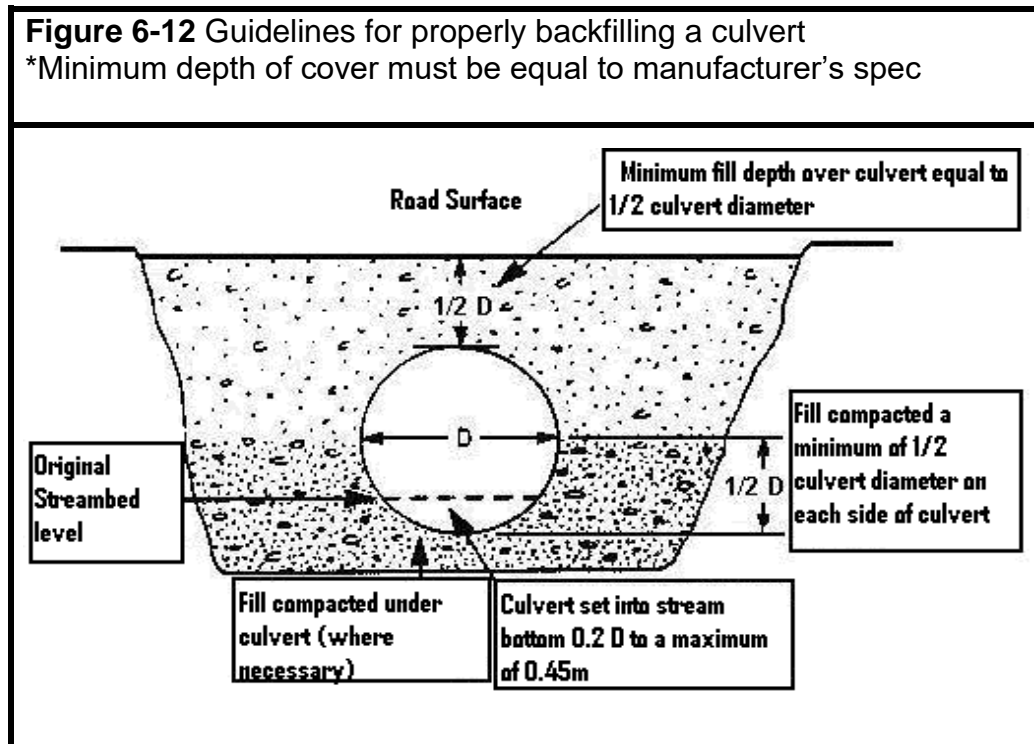

6.7.5 Stabilization

The ends of a culvert can be stabilized using rip-rap or headwalls and wingwalls. These structures protect the fill material around the ends of the culvert against scouring and erosion. The general guidelines for use of these stabilization techniques are as follows:

- As a minimum, these stabilization techniques must protect the portion of the foreslopes of the road around the ends of the culvert from the elevation of the stream bed to half the diameter/span of the structure above the top of the culvert and for a minimum distance of one culvert diameter/span on each side of the culvert. See Figure 6-11.
- Stabilize the foreslopes immediately following the installation, before it begins to convey the stream flow.

- The foreslopes above the rip-rap or headwalls/wingwalls can be stabilized with vegetation provided the foreslopes are no steeper than a 1.5 to 1 slope. See Figure 6-11.

The following information is specific to each stabilization technique.

Rip-rap

Rip-rap is defined as durable broken rock, cobble or boulders placed over exposed soil to provide an erosion-resistant cover.

- Rip-rap must be clean, durable, non-ore-bearing, non-toxic rock and must not be obtained from a watercourse nor from within 30 metres (100 ft) of a watercourse/wetland.
- Rip-rap must be irregular in shape with at least 70% of the material having a smallest dimension of not less than 15 centimetres (6 in).
- The foreslopes the rip-rap is to be placed on must be no steeper than 1.5 horizontal to 1 vertical.
- The minimum thickness of the layer of rip-rap must be 1.33 times the maximum rock size used.
- Rip-rap must not be dumped or pushed over the shoulder of the foreslopes but must be placed into position in a controlled manner.

Headwalls

Headwalls are vertical walls that are aligned parallel to the roadway and tied into the slopes of the road embankment. Headwalls may be used alone or in conjunction with rip-rap. Headwalls are an effective means of achieving the desired road width, where factors are limiting the length of the culvert.

Headwalls are designed to:

- Retain the roadway embankment preventing fill material from entering the watercourse

Figure 6-13 Foreslope stabilization around a culvert

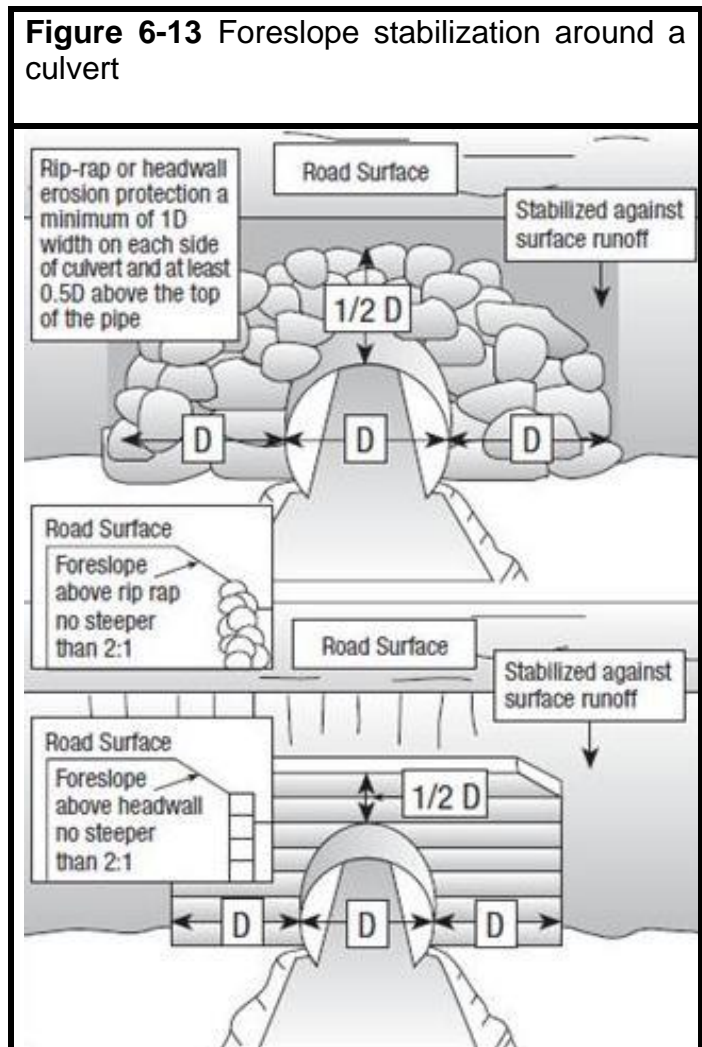

- Anchor the culvert against potential buoyancy or uplifting
- Provide support to the culvert inlet and outlet to help maintain the shape and waterway opening of the culvert
- Increase the hydraulic efficiency of the culvert
- Prevent saturation of the backfill

When constructing headwalls:

- Excavate the location for the headwalls below the anticipated depth of scour
- Use squared timber, concrete, steel, gabions, etc. to construct the structure
- Tie the headwalls into the foreslope for stability

Wingwalls

Wingwalls are lateral walls similar to headwalls except that they extend upstream and downstream from the outside corners of the headwalls at an oblique angle to the road embankment. Wingwalls improve the hydraulic efficiency of most culverts flowing under inlet control.

The information listed in the headwalls section also applies to the construction of wingwalls.

6.7.6 Road Approaches

Road approaches should be straight and stable with minimal slope for 30 metres (100 ft) on both sides of the watercourse crossing.

Locate off-takes or cross-drainage culverts at least 30 metres (100 ft) from watercourses/wetlands. If the topography permits, construct off-take ditches on both sides of the road.

Where property ownership allows, roadside ditches must end at least 30 metres (100 ft) from watercourses/wetlands and water directed through an off-take ditch. Ditches must never discharge directly into a watercourse/wetland.

Clearing and grubbing activities within 30 metres (100 ft) of the watercourse must be limited to the footprint on the approaches and the roadside ditches (if included). Clearing activities may occur prior to June 1st (to avoid the nesting season) if all other applicable federal and provincial requirements are met. Grubbing shall not take place until construction of the crossing is ready to begin.

6.8 ENERGY DISSIPATION POOLS

The use of an energy dissipation pool at the outlet of a culvert serves two purposes:

- To dissipate the energy from incoming water and to prevent brook destabilization and scouring at the outlet. If scouring occurs at the outlet, it may create a “hanging” culvert, preventing fish passage.
- To provide a resting area for migrating fish. The energy dissipation pool should be sized to ensure the stability of the pool during peak flood flows.

Energy dissipation pools must be constructed at the outlet of all closed-bottom culverts, where the stream slope is greater than 0.5%.. See Figure 6-12.

Note: Energy dissipation pools are not required for stream simulation culverts. See Section 6.9 *Stream Simulation Culverts*.

6.8.1 Design

Appropriate channel protection must be designed to prevent scour and erosion at the outlet of the culvert such that the natural bed and banks can withstand the flow velocity during a peak runoff event.

To prevent scour and erosion, the entire energy dissipation pool should be stabilized and lined with rip rap at least 1.5 times the thickest rock. The size and placement of rip-rap must be resilient enough to withstand velocities produced by the 1:100 year flood event.

Three to five large boulders (1 metre (3 ft) in diameter) should be staggered in the energy dissipation pool in order to further dissipate energy and provide fish habitat. The top of the boulders should not protrude above the elevation of the outlet control riffle.

The average depth of the pool must be a minimum of 1 metre (3 ft).

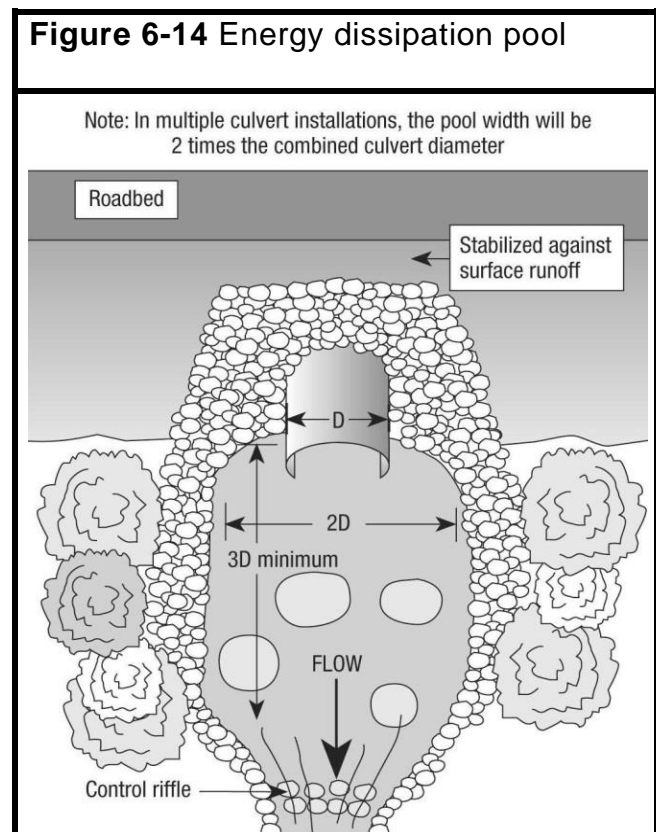

The width at the bottom of the dissipation pool is to be two times the culvert diameter (D). The length at the bottom of the dissipation pool is to be three times the culvert diameter (D).

An appropriate amount of fine granular material, gravel borrow, or pit run material (20% fines, does not include clays) should be mixed with the rock mixture to ensure that the interstitial spaces are filled so that water is not lost. When completed properly and to ensure fish passage, water should flow over the rip rap and not completely disappear.

To avoid sedimentation of the watercourse downstream, the newly constructed energy dissipation pool should be “washed” or “flushed” thoroughly to dislodge any fine material. The wash-water should be pumped away from the watercourse to prevent sedimentation of the watercourse. Once the water is running clean, then the permanent watercourse can be re-directed through the culvert.

After construction is complete, ensure to stabilize all disrupted soils to avoid erosion and sedimentation of the watercourse. Short term strategies include the use of hay/straw mulch. However, for long term stability, shrubs, bushes, and/or trees should also be planted to establish root growth.

6.9 STREAM SIMULATION CULVERTS

A stream simulation culvert is a closed-bottom culvert featuring a natural stream bed within the structure, which mimics the substrate found in the watercourse and adds roughness to reduce water velocities. This design methodology has existed in some form for decades and is also known as an “embedded” design or “stream smart” design.

Note: Fisheries and Oceans Canada (DFO) is currently reviewing and updating fish watercourse crossing guidelines. Since these new guidelines center on open-bottom and stream simulation designs, proponents are encouraged to adopt this design in lieu of closed-bottom culverts with baffles. It is expected that all closed-bottom culverts, with few exceptions, will eventually be required to be designed as stream simulation culverts.

Under the Watercourse Alteration Certification Program, stream simulation culverts can be installed up to a 6% stream slope. For watercourses with gradients above 6%, the United States Forest Services Guide for Stream Simulation (available at https://www.fs.fed.us/eng/pubs/pdf/StreamSimulation/hi_res/%20FullDoc.pdf) should be consulted. These designs are not covered under the Watercourse Alteration Certification Program and will require a standard WAWA permit.

Stream simulation should conform to four design parameters, which are described in the follow sections. The parameters, coined by Maine Audobon and the Maine Department of Transportation

(https://www.maine.gov/mdot/publications/docs/brochures/pocket_guide_stream_smart_web.pdf) as the four “S”s are:

- Span the Stream
- Set the Elevation Right
- Slope Matches the Stream
- Substrate in the Crossing

In addition to the information in the sections below, the installation guidelines in Section 6.7 *Closed-Bottom Culvert Installation*, should be followed.

6.9.1 Span the Stream

The culvert must be sized at least 1.2 times the bankfull width (BFW) of the watercourse. The BFW can be determined through a stream survey that is conducted outside of the area influenced by an existing structure (sediment deposition, channel incision) in cases of culvert replacements. Spanning the stream ensures that there is no constriction of the watercourse which often results in debris jams, destructive hydraulic effects or increased risks of structure failure. The culvert must also be sized to accommodate a 1 in 100-year runoff event accounting for the depth of fill in the structure.

Note: Under the Watercourse Alteration Certification Program, determining the proper size of a culvert must be carried out by a certified designer.

For culvert replacements, consideration of fill depth, bedrock, underground utilities, or the permissibility of road closures may necessitate additional technical help in design and construction.

Unfamiliarity with this design approach may mean that it will take time for local suppliers to create or stock structures that can facilitate stream simulation. For instance, common structures used in other jurisdictions include box culverts with lids and large, corrugated aluminum pipes.

There is no minimum or maximum size for stream simulation culverts provided that BFW sizing is followed. However, culverts smaller than 1800 mm (72 in) can pose problems with adding substrate into the pipe. See Figure 6-15.

Figure 6-15 Stream simulated culvert cross-section

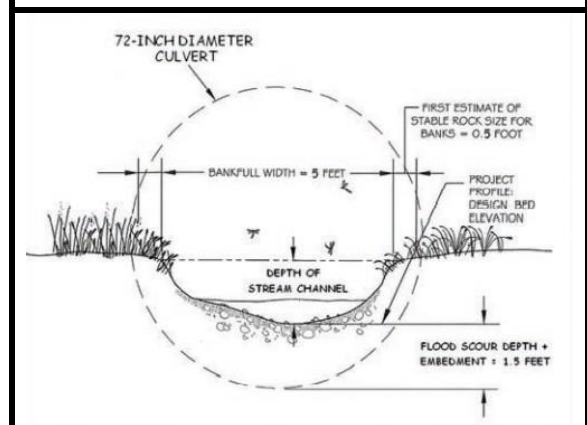

6.9.2 Set the Elevation Right

Circular culverts should be embedded to at least 0.4 times the diameter of the pipe; arches and boxes are to be embedded to at least 0.2 times the height.

Ideally the bottom of the culvert should be located below the scour line (the depth of the deepest pool not including any scour pool in the watercourse above and below the culvert) so that the stream bed in the culvert is unlikely to erode enough to expose the culvert bottom. If bedrock is encountered then an open-bottom structure or bridge should be used.

6.9.3 Slope Matches the Stream

The culvert must match the existing stream gradient such that there is no break in slope from the watercourse to the substrate in the crossing. This will ensure there is no excess substrate accumulation at the inlet or headcut formation at the outlet.

A stream gradient measured from the first upstream and first downstream riffles at an existing crossing may under or over estimate the natural stream gradient. The gradient of the stream should ideally be determined from a reference reach outside the influence of an existing structure in cases of culvert replacements.

6.9.4 Substrate in the Crossing

Substrate within the culvert must match the natural stream bed material found in the watercourse. Either reclaimed stream bed material or a mix similar to what is present naturally should be used.

The new stream bed mix should have a wide range of particle sizes and must include enough silts and fines (particles less than 2 mm in diameter) to fill interstitial spaces and create an impermeable surface. Fines should be washed into the stream bed with a hose until the water runs clear. If subsurface flow is still evident then more fines and washing may be required.

Sediment laden water generated by this process must be captured at the downstream end and pumped into a densely vegetated area a sufficient distance from a watercourse/wetland to filter any silt from the runoff before it returns to a watercourse/wetland.

For streams larger than 2 metres (6.6 ft) in width, large rocks should be placed in a meandering pattern within the culvert and embedded 50% of their diameter. Larger rocks should also be placed to act as banks along the sides of the culvert.

If the watercourse substrate consists mostly of silt, sand and fine gravel then proper embedment of the structure should allow for the deposition of material inside of the pipe sufficient to provide passage for fish.

6.10 REPLACING CULVERTS

For guidelines on replacing a closed-bottom culvert with an open-bottom culvert, see Section 7.3.8 *Replacing a Closed-Bottom Culvert with an Open-Bottom Culvert*. For guidelines on replacing a closed-bottom culvert with a bridge, see Section 7.9.1 *Replacing a Closed-Bottom Culvert with a Bridge*.

When replacing a culvert, the length of the new culvert must not exceed 30 metres (100 ft).

All other guidelines for culvert sizing, fish passage, timing of installation, culvert installation, and energy dissipation pools must be followed. See Section 6.3 to Section 6.8.

MODULE 7: INSTALLATION OF AN OPEN-BOTTOM CULVERT AND BRIDGE CONSTRUCTION TIER REVIEW APPROACH

TIER 1 (5-day review)

- **New open-bottom culverts** (max length 25 m, max drainage area 20 km²)
- **Replacing open-bottom culverts** (max length 30 m, max drainage area 20 km²)
- **Replacing a closed-bottom culvert with an open-bottom culvert or bridge** (max length for culvert 30 m, max drainage area 20 km²)
- **Removing (decommissioning) open-bottom culverts and bridges**
- **Temporary bridge over a watercourse or wetland**
- **Temporary wetland crossing** (footprint less than 100 sq. m)

TIER 3 (requires a standard WAWA permit)

- Any crossing not sized for the 1 in 100-year flood event
- Constructing a bridge with instream support(s)
- Any alterations resulting in a permanent wetland impact greater than 100 sq. m
- Any alterations in and within 30 m of a provincially significant wetland (PSW)
- Any alterations within a designated [watershed](#) or [wellfield](#) used as a source for public water supply
- Replacing an open-bottom culvert where there is an aquatic species (or habitat) at risk under the [Species at Risk Act](#) where there is a reduction of end-area or extension of infrastructure footprint
- Any other activity not approved under Tier 1 or exceeding the guidelines

7.0 INSTALLATION OF AN OPEN-BOTTOM CULVERT AND BRIDGE CONSTRUCTION

Open-bottom culverts and bridges are the preferred crossing structures for fish passage simply because the natural stream bed is maintained. These structures are not constrained by watercourse gradient and choosing one of these options will expedite the approval process as less review is required.

7.1 OPEN-BOTTOM CULVERTS

A properly sized culvert should not impede fish passage, increase the velocity of the stream flow, or alter the aquatic habitat. In situations where the span of an open-bottom culvert is inadequate, thereby constricting the flow, the increase in stream flow velocity may result in stream bed scour and/or undermining of the footings, potentially causing the structure to fail.

7.1.1 Basic Standards

The following steps should be followed to determine the minimum waterway opening required under an open-bottom culvert for the stream flow to pass through.

- A properly sized culvert must have the capacity to accommodate a 1 in 100-year runoff event. This does not mean it will occur only once in every 100 years. It means that there is a one percent probability of such an event occurring in any given year.
- All instream (*i.e.* below the bankfull width of a watercourse, whether wetted or not) work must be carried out in isolation of the stream flow.

Note: Although a certified installer may carry out the installation of culverts (provided a Watercourse and Wetland Alteration (WAWA) permit has been obtained for the work), under the Watercourse Alteration Certification Program, the submission for the WAWA permit for watercourse crossings requiring designs and drainage area calculations can only be submitted by a certified designer.

7.2 OPEN-BOTTOM CULVERT SIZING

A properly sized culvert must have the capacity to accommodate a 1 in 100-year runoff event. This does not mean it will occur only once in every 100 years. It means that there is a one percent probability of such an event occurring in any given year.

Under the Watercourse Alteration Certification Program, sizing of culverts and bridges must be carried out by a certified designer.

7.3 OPEN-BOTTOM CULVERT INSTALLATION

The steps for installing an open-bottom culvert have been separated into the following categories:

- Timing of Installation
- Environmental Considerations
- General Practices
- Working in Isolation of the Stream Flow
- Installation
- Stabilization
- Road Approaches
- Replacing a Closed-Bottom Culvert with an Open-Bottom Culvert

7.3.1 Timing of Installation

All open-bottom culvert installations must be carried out between June 1st and September 30th of the same year, preferably during low flow conditions. The construction should proceed diligently to help prevent any unnecessary environmental problems and minimize impacts to fish.

Note: Longer projects benefit from water-control methods which provide fish passage (e.g. a diversion channel).

Work and project extensions outside of this window will not be approved through the Watercourse Alteration Certification Program. If there are unforeseen issues that prevent the project from being completed prior to the September 30th deadline, DELG should be contacted as soon as possible to discuss next steps.

7.3.2 Environmental Considerations

Erosion/sedimentation and fish passage are two of the environmental issues that must be addressed with this type of structure. An open-bottom culvert avoids the requirement for fish passage facilities provided it is installed such that the structure, including the footings, is landward of the shoulders of the banks of the watercourse. See Figure 7-1.

The pre-construction stability of the banks and bed of the watercourse is a concern and must be considered during installation.

This type of structure is less likely to be dammed by beavers than closed-bottom culverts.

Figure 7-1 Open-bottom culvert – new installation

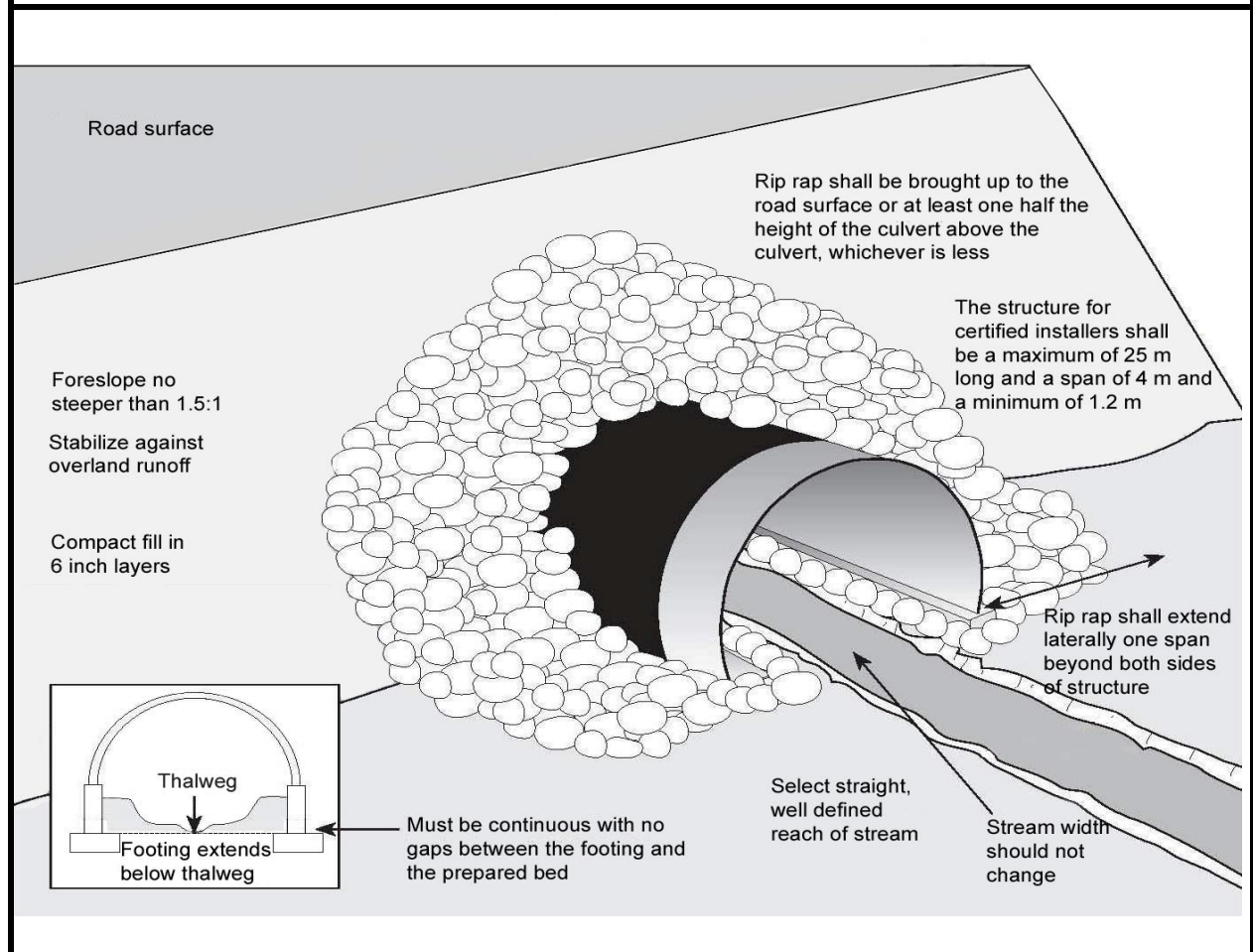

7.3.3 General Practices

The realignment of a stream to ensure a 90-degree crossing or to straighten or alter the stream channel in any way is not permitted under the Watercourse Alteration Certification Program.

The following must be followed when using machinery in or near a watercourse.

- A backhoe or an excavator must be used to prepare a firm bed for the placement of the structure
- All work must be carried out with machinery stationed outside the wetted portion of the channel (fording is not permitted)
- Machinery must be in good working order and must not be leaking any fuel, lubricants, or hydraulic fluid and must be cleaned/degreased to prevent any deleterious substance from contaminating the wetland and to help minimize the spread of invasive plant species

- Machinery must not be washed/refueled in or near a watercourse/wetland; this practice is not limited to the crossing site but anywhere that contaminated overland runoff seeps or drains into a watercourse/wetland

Prior to the culvert being installed, if machinery must cross the watercourse, it must do so using a temporary or portable bridge that completely spans the channel to minimize the potential for erosion and sedimentation. See Section 7.10 *Temporary Bridges* for the associated guidelines. Machinery must not ford a watercourse at any time during the installation, replacement, or maintenance of watercourse crossings.

Clearing and grubbing activities within 30 metres (100 ft) of the watercourse must be limited to the footprint on the approaches and the roadside ditches (if included). Clearing activities may occur prior to June 1st (to avoid the nesting season) if all other applicable federal and provincial requirements are met. Grubbing shall not take place until construction of the crossing is ready to begin

7.3.4 Working in Isolation of the Stream Flow

All activities in the wetted footprint of the channel must be carried out in isolation of the stream flow.

When working in a watercourse, it is necessary to isolate the work site from the stream flow to reduce the impact of silt and fine particulate matter on fish and their habitat. Effective techniques of water control include using cofferdams in combination with a pump-around system and temporary diversion channels. See Section 5.1 *Water Control Measures when Working in a Watercourse* for more details.

7.3.5 Installation

Prefabricated structures must be installed using machinery that can lift the components into place. Prefabricated structures must not be dragged across a watercourse into position.

The crossing must be installed over a reach of stream channel that is relatively straight and well defined.

Open-bottom culverts must be founded on continuous footings/stem walls. The footings must be placed on a compacted bed of gravel to provide uniform support. The footings may be steel, concrete, rigid plastic, wood that is rot-resistant such as hemlock and tamarack, or other materials that will provide adequate support of the structure.

The footings must be buried below the thalweg such that the base of the footing is below the possible depth of scour. Otherwise, the foundation must be designed by a professional engineer licensed to practice in New Brunswick.

All backfill material over the footing or against the channel side of the stem wall must be capped with rock without constricting the channel.

The height of cover and compaction around the structure must be in accordance with the manufacturer's specifications.

7.3.6 Stabilization

Rip-rap and/or a headwall must extend along the foreslope on both sides of the structure at least one span width. Erosion protection must also extend up to the shoulder of the road or half the rise above the top of the arch, whichever is less. If the rip-rap does not extend up to the road shoulder, the remainder of the foreslopes above the rip-rap must be no steeper than 1.5 horizontal to 1 vertical and must be stabilized against surface runoff. See Figure 7-2.

The following information is specific to each stabilization technique.

Rip-rap

Rip-rap is defined as durable broken rock, cobble or boulders placed over exposed soil to provide an erosion-resistant cover.

- Rip-rap must be clean, durable, non-ore-bearing, and non-toxic rock, and must not be obtained from a watercourse nor from within 30 metres (100 ft) of a watercourse/wetland.
- Rip-rap must be irregular in shape, with at least 70% of the material having a smallest dimension of not less than 15 centimetres (6 in).
- The foreslopes the rip-rap is to be placed on must be no steeper than 1.5 horizontal to 1 vertical.
- The minimum thickness of the layer of rip-rap must be 1.33 times the maximum rock size used.
- Rip-rap must be placed with machinery capable of controlling its placement and must not be dumped or pushed over the shoulder of the foreslope.

Headwalls

Headwalls are vertical walls that are aligned parallel to the roadway and tied into the slopes of the road embankment. Headwalls may be used alone or in conjunction with rip-rap. Headwalls are an effective means of achieving the desired road width, where factors are limiting the length of the culvert.

Headwalls are designed to:

- Retain the roadway embankment preventing fill material from entering the watercourse
- Anchor the culvert against potential buoyancy or uplifting

- Provide support to the culvert inlet and outlet to help maintain the shape and waterway opening of the culvert
- Increase the hydraulic efficiency of the culvert
- Prevent saturation of the backfill

When constructing headwalls:

- Excavate the location for the headwalls below the anticipated depth of scour
- Use squared timber, concrete, steel, gabions, etc. to construct the structure
- Tie the headwalls into the foreslope for stability

Wingwalls

Wingwalls are lateral walls similar to headwalls except that they extend upstream and downstream from the outside corners of the headwalls at an oblique angle to the road embankment.

The information listed in the headwalls section also applies to the construction of wingwalls.

7.3.7 Road Approaches

Road approaches should be straight and stable with a minimal slope for 30 metres (100 ft) on both sides of the watercourse crossing.

Locate off-takes or cross-drainage culverts at least 30 metres (100 ft) from watercourses/wetlands. If the topography permits, construct off-take ditches on both sides of the road.

Where property ownership allows, roadside ditches must end at least 30 metres (100 ft) from watercourses/wetlands and water directed through an off-take ditch. Ditches must never discharge directly into a watercourse/wetland.

Clearing and grubbing activities within 30 metres (100 ft) of the watercourse must be limited to the footprint on the approaches and the roadside ditches (if included). Clearing activities may occur prior to June 1st (to avoid the nesting season) if all other applicable federal and provincial requirements are met. Grubbing shall not take place until construction of the crossing is ready to begin.

7.3.8 Replacing a Closed-Bottom Culvert with an Open-Bottom Culvert

In addition to the guidelines in Section 7.3 *Open-Bottom Culvert Installation*, the following guidelines must be followed.

Figure 7-2 Open-bottom culvert – replacement

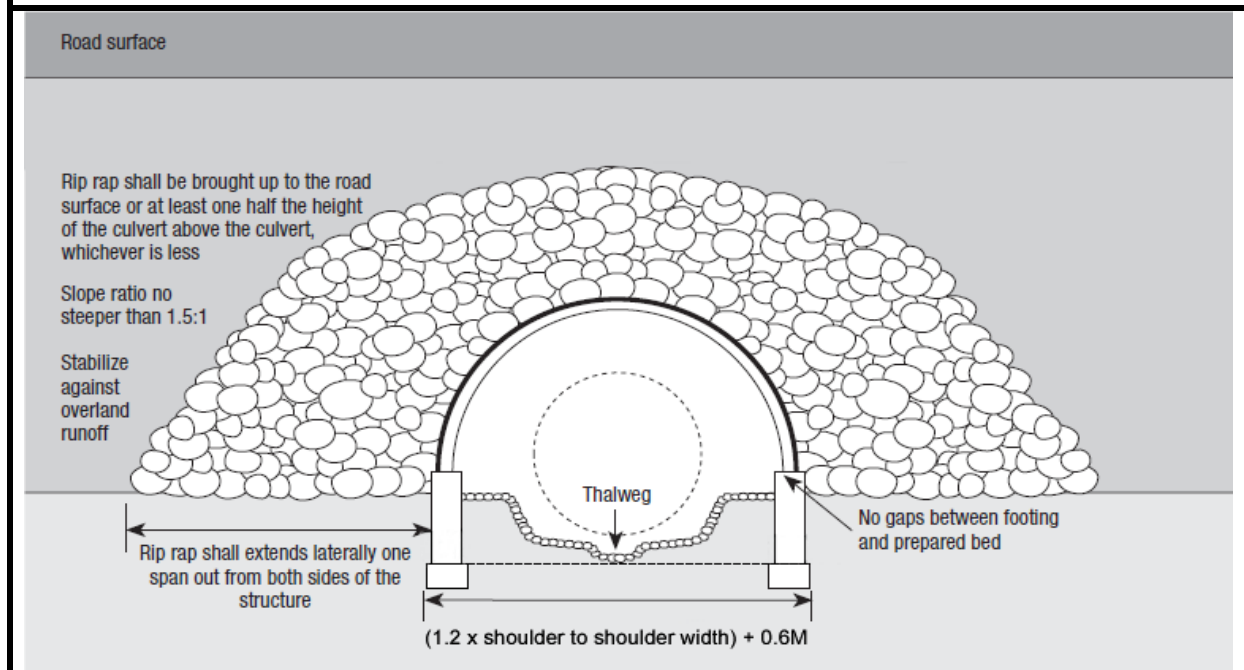

The reconstructed channel must be restored to its natural grades and to the cross-section immediately upstream and downstream of the altered area (*i.e.* a reference reach outside of the impacted zone). See Figure 7-2.

The substrate in the new channel should be a mix consisting of rock that mimics what is present naturally in the watercourse or should use reclaimed stream bed material.

The new stream bed mix should have a wide range of particle sized and must include enough silts and fines (particles less than 2 mm in diameter) to fill interstitial spaces and create an impermeable surface. Fines should be washed into the stream bed with a hose until the water runs clear. If subsurface flow is still evident then more fines and washing may be required.

Small particle sizes are of critical importance for stream bed mixes as a lack of these fines can cause water to flow below the surface of the new channel. It should never be assumed that sediment will be transported from upstream to plug the stream bed as this process could take years.

7.4 BRIDGES VERSUS CLOSED-BOTTOM CULVERTS

7.4.1 Environmental Considerations

Bridges are the preferred watercourse crossing type from an environmental and fisheries standpoint for the following reasons:

- Bridges retain the natural stream bed
- Bridges maintain the cross-sectional area of the channel, therefore maintaining the natural flow regime
- Bridges rarely provide a barrier to fish passage
- Bridge construction requires less instream activity, therefore minimizing the potential for environmental impacts

7.5 PERMANENT BRIDGES

A bridge is defined as a structure built over a watercourse, the deck of which forms a link in the road, footpath, or railbed.

7.5.1 Basic Standards

The Watercourse Alteration Certification Program allows for the construction of bridges that completely span the channel only. The program does **not** permit the construction of multiple span bridges or bridges requiring any instream supports. For these types of structures, an application for a standard watercourse and wetland alteration permit must be made using the [online application program](#).

Single span bridge construction must comply with the following guidelines.

- A properly sized bridge must have the capacity to accommodate a 1 in 100-year runoff event. This does not mean it will occur only once in every 100 years. It means that there is a one percent probability of such an event occurring in any given year.
- All work in the wetted portion of the watercourse work shall be isolated from the stream flow with cofferdam(s) such that there is an unobstructed area maintained throughout the construction that is of sufficient width to allow for fish passage and water flow. A good practice is to leave at least two-thirds of the channel unobstructed at all times. The height of the cofferdam(s) shall be sufficient so that it does not get overtopped during heavy rain or sudden high-water event.
- The bridge must cross the watercourse where the channel is straightest and narrowest, and the banks are stable. **Note:** During the construction of a new bridge, the realignment of a stream to ensure a 90-degree crossing or to straighten or alter the stream channel in any way is not permitted under the Watercourse Alteration Certification Program. If a stream realignment is being proposed, an application for a standard watercourse and wetland alteration permit must be made using the [online application program](#).

- The abutments must be situated landward of the shoulder of the banks of the watercourse and aligned so as not to cause the flow to be directed into the banks of the watercourse.
- The base of the abutments must be set below the thalweg such that the base is below the possible depth of scour, or otherwise protected from scour by locating the abutments outside the expected high-water line and armoring them appropriately.
- The rise (distance from the stream bed to the underside of stringers) of bridges must provide sufficient clearance for ice flows, debris, and navigation (in compliance with the [Canadian Navigable Waters Act](#)).

7.6 BRIDGE MATERIAL

Acceptable materials for constructing bridges include wood, concrete, or steel.

When using these materials in bridge construction, see Section 5.4 *Materials Used in and Near Watercourses and Wetlands* for more details.

7.7 BRIDGE SIZING

A properly sized bridge should not impede fish passage, increase the velocity of the stream flow, or alter the aquatic habitat. In situations where the span of a bridge is inadequate, thereby constricting the flow, the increase in stream flow velocity may result in stream bed scour and undermining of the abutments, potentially causing the bridge to fail.

Bridges must be designed with a hydraulic capacity large enough to pass a 1 in a 100-year runoff event.

7.7.1 Bridge Length

Under the Watercourse Alteration Certification Program, the following applies to the length of the bridge:

- The abutments must be situated landward of the shoulder of the banks of the watercourse and aligned so as not to cause the flow to be directed into the banks of the watercourse
- The bridge design must not include piers or other instream intermediate structural supports

7.8 BRIDGE CONSTRUCTION

The steps for constructing a bridge have been separated into the following categories. Information on each of these categories and their associated guidelines is provided below.

- Timing of Construction
- General Practices
- Working in Isolation of the Stream Flow
- Constructing Bridge Abutments
- Constructing a Bridge
- Protecting the Bridge Abutments
- Road Approaches

7.8.1 Timing of Construction

All instream (*i.e.* below the bankfull width of a watercourse, whether wetted or not) work, including the construction of the abutments, must be carried out between June 1st and September 30th of each year, preferably during low water conditions. Construction should proceed diligently to help minimize any unnecessary environmental problems.

Work and project extensions outside of this window will not be approved through the Watercourse Alteration Certification Program. If there are unforeseen issues that prevent the project from being completed prior to the September 30th deadline, DELG should be contacted as soon as possible to discuss next steps.

7.8.2 General Practices

The following must be followed when using machinery in or near a watercourse.

- All work must be carried out with machinery stationed outside the wetted portion of the channel (fording is not permitted)
- Machinery must be in good working order and must not be leaking any fuel, lubricants, or hydraulic fluid and must be cleaned/degreased to prevent any deleterious substance from contaminating the wetland and to help minimize the spread of invasive plant species
- Machinery must not be washed/refueled in or near a watercourse/wetland; this practice is not limited to the crossing site but anywhere that contaminated overland runoff seeps or drains into a watercourse/wetland

Prior to the bridge being constructed, if machinery must cross the watercourse, it must do so using a temporary or portable bridge that completely spans the channel to minimize the potential for erosion and sedimentation. See Section 7.10 *Temporary Bridges* for the associated guidelines. Machinery must not ford a watercourse at any time during the installation, replacement, and maintenance of watercourse crossings.

Clearing and grubbing activities within 30 metres (100 ft) of the watercourse must be limited to the footprint on the approaches and the roadside ditches (if included). Clearing activities may occur prior to June 1st (to avoid the nesting season) if all other applicable federal and provincial requirements are met. Grubbing shall not take place until construction of the crossing is ready to begin.

7.8.3 Working in Isolation of the Stream Flow

All activities in the wetted portion of the channel must be carried out in isolation of the stream flow. See Section 5.1 *Water Control Measures when Working in a Watercourse* for more details.

7.8.4 Constructing Bridge Abutments

Abutments are the component of the bridge that the stringers are founded on, which also retain and help protect the banks of the watercourse from the pressure of the traffic using the bridge. Abutments are generally constructed from concrete, wood, steel, or aluminum.

Acceptable types of abutments include:

- Pre-manufactured galvanized steel abutment
- Cast-in-place concrete
- Squared timber crib
- Pre-cast concrete or other earth retaining products designed specifically for abutments

The following guidelines must be followed when constructing bridge abutments:

- The abutments must be situated landward of the shoulder of the banks of the watercourse and aligned so as not to cause the flow to be directed into the banks of the watercourse
- Set the base of the abutments below the thalweg such that the base is below the possible depth of scour, or otherwise protected from scour by locating the abutments outside the expected high-water line and armoring them appropriately.
- Use clean backfill material that is uniformly graded, free-draining, or pit run gravel, which allows for good compaction
- Ideally, complete construction of one abutment before starting to construct the other one

Prepare the foundation, using the following procedure:

- Excavate the footprint for the abutment below the possible depth of scour
 - If firm material is being removed, excavate to a minimum depth of 30 centimetres (12 in) below the thalweg of the stream bed
 - If soft material is being removed, excavate to solid ground

- Where an abutment will not be founded on bedrock, level the base of the excavation with a minimum of 15 centimetres (6 in) thick layer of well-compacted gravel

7.8.5 Constructing a Bridge

Before construction commences, ensure the site is isolated from stream flow. See Section 5.1 *Water Control Measures when Working in a Watercourse* for more details.

Note: This section contains general guidelines on the construction of a bridge. Other methods may be acceptable following the review of design plans by the New Brunswick Department of Environment and Local Government.

Place a sill (bearing plate) inside the completed abutments parallel to the top face timber (panel). The timber sills (bearing plate) or concrete pads support the end of the stringers.

Place butt plates behind the sills to allow for proper backfilling of the road approach and to prevent the stringers from sliding off the sills.

Span the abutments with stringers that are aligned with the approaches.

Place cross-decking perpendicular to the stringers. The cross-decking should overhang the outside of the stringers equally on both sides of the bridge.

If placing travel planking or wheel runs, they should be perpendicular to the cross-decking to protect the deck from wear.

- Travel planking should be wide enough and spaced the proper distance to accommodate any vehicle that will be travelling across the bridge.

Place curbing and guide rails along both sides of the bridge as a guide to traffic.

7.8.6 Protecting the Bridge Abutments

The upstream and downstream corners of the bridge abutments must be stabilized using either rip-rap or wingwalls to help protect them from scouring or undermining.

Rip-rap

Rip-rap is defined as durable broken rock, cobbles or boulders placed over exposed soil to provide an erosion-resistant cover.

- Rip-rap must be clean, durable, non-ore-bearing, and non-toxic rock, and must not be obtained from a watercourse nor from within 30 metres (100 ft) of a watercourse/wetland.
- Rip-rap must be irregular in shape, with at least 70% of the material having the

smallest dimension of not less than 15 centimetres (6 in).

- Rip-rap must be placed around the corners of the bridge but must not encroach beyond the toe of the present-day bank of the watercourse and must not cover any of the exposed mineral/organic soil substrate.
- The foreslopes the rip-rap is to be placed on must be no steeper than 1.5 horizontal to 1 vertical.
- The minimum thickness of the layer of rip-rap must be 1.33 times the maximum rock size used.
- Rip-rap must be placed with machinery capable of controlling its placement and must not be dumped or pushed over the shoulder of the foreslope.

Wingwalls

Wingwalls are lateral walls that extend obliquely from the upstream and downstream corners of the abutments providing erosion protection, bank stabilization and structural integrity.

To construct wingwalls:

- Excavate the footprint for the wingwalls below the anticipated depth of scour to approximately the same depth the base of the abutments is set at
- Use tiebacks to hold wingwalls in place
- As a minimum, wingwalls must be constructed to the height of the shoulder of the banks of the watercourse

7.8.7 Road Approaches

The top of the bridge should be slightly higher than the level of the approaches to allow floodwater to overtop the road rather than damage the bridge.

For additional information with regards to road approaches, see Section 6.7.6 *Road Approaches*.

7.9 REPLACING BRIDGES

The following sections provide guidelines on replacing a single-span bridge.

7.9.1 Replacing a Closed-Bottom Culvert with a Bridge

When replacing a closed-bottom culvert with a bridge, the guidelines for permanent bridge construction must be followed, in addition to the guidelines of reconstructing a channel. See Section 7.3.8 *Replacing a Closed-Bottom Culvert with an Open-Bottom Culvert*.

7.9.2 Replacing the Decking of a Bridge

The replacement of a deck on a bridge is not considered an “alteration” and therefore, does not require a watercourse and wetland alteration permit, provided the following conditions can be met:

- The stringers of the bridge must not be altered
- The only components of the structure being replaced are the cross-decking, travel planking, curbing, posts for signage, and/or guide rails
- No debris must be allowed to fall into the water
- No machinery must enter a wetland or the wetted portion of the watercourse

Placing a temporary superstructure over an existing watercourse crossing is not considered re-decking. This activity is only permitted if the following can be met:

- The new superstructure must be temporary and only stay in place for one season; **it must be removed before the next freshet**
- The pre-existing structure must be able to accommodate a 1 in 2-year runoff event
- An application for a Watercourse and Wetland Alteration for bridge maintenance must be submitted through the [online application system](#) for this activity

7.10 TEMPORARY BRIDGES

Temporary bridges are either prefabricated structures or structures fabricated on-site that provides access across the watercourse for a limited period of time. They are generally used to either:

- Provide the machinery with access across a watercourse while a permanent crossing structure is being constructed
- Provide temporary access across a watercourse for short term use

Note: Although most modular panel bridges are temporary in nature, the guidelines for a permanent bridge should be followed as these structures will likely be in place over the freshet season(s) before a permanent bridge is constructed. See Sections 7.5 to 7.8 for more information.

The steps for constructing a temporary bridge have been separated into the following categories:

- General Practices
- Temporary Bridge Construction

7.10.1 General Practices

Under the Watercourse Alteration Certification Program, temporary bridges are not permitted in a wetland or in or within 30 metres (100 ft) of a provincially significant wetland (PSW). **Note:** The references to wetlands in the following guidelines apply to only those that are not considered PSWs. There is to be no permanent impact to a wetland during the installation of a temporary bridge.

- Temporary bridges may be installed and left in place between June 1st and March 19th only, whenever the stream flow is confined to the channel. The bridge must be fabricated such that the components that span the channel can be quickly and easily removed.
- During mild weather and/or precipitation events, which may occur during the permitted timeframe when the temporary bridge may be in place, the water level beneath the structure must be closely monitored. The bridge must be removed before the water level reaches its underside. The temporary bridge may be reinstalled following the high flow event once the stream flow is contained within the channel banks.
- Construction of the temporary bridge must not involve any instream work or stationing of machinery in the wetted portion of the channel or in a wetland.
- At the first evidence of machinery causing ruts within 30 metres (100 ft) of a watercourse/wetland, the machinery must not advance any further, and the ruts must be immediately smooth graded and blanketed with mulch or slash.
- Soil disturbance and fill placement within 30 metres (100 ft) of a watercourse/wetland must be limited to the footprint required to prepare a stable foundation for the structure.
- No grubbing must take place within 30 metres (100 ft) of a watercourse/wetland.
- The cleared width of the approaches to the crossing must not exceed 1.5 times the width of the temporary bridge.
 - The approaches to the crossing must be stabilized against erosion by using brush mats or clean material unless bedrock is suitable to protect from rutting. Stabilization should extend back at least 30 metres (100 ft) on both sides of the crossing.
- To minimize erosion and siltation, temporary crossings must be limited to a single location perpendicular to the channel where the banks are firm and stable, and the channel is narrow.
- Prefabricated structures must be lifted into place over the channel and removed in the same manner.
- Construction materials must not be treated with creosote or other toxic products. Treated timbers must be air-dried for the length of time specified by the manufacturer for safe use in, over, or near aquatic environment.
- The span of the temporary bridge must be wide enough to ensure that any soil disturbance required to prepare a stable foundation does not result in placing any material below the shoulder of the banks of the watercourse.
- The supporting structure or other types of foundation materials must be placed at least 0.5 metre (20 in) back from the shoulder of the banks of the watercourse. The

underside of the stringers must be at least 250 millimetres (10 in) above the shoulder of the banks of the watercourse or 750 millimetres (30 in) above the stream bed, whichever is greater.

- Temporary bridges composed of a single supporting structure (e.g. square timber) on both sides of the watercourse must have spacers attached to the underside of the stringers to maintain the span between them.
- Bridge decking must be tightly laminated together. Any soil that accumulates on the deck must be removed in such a way that it does not enter the stream flow. At unstable (e.g. muddy) approaches, once the stringers are spanning the channel, an impervious membrane must be placed between the stringers and the decking to prevent debris/mud from entering the stream flow.
- Harvested timber must not be skidded across a temporary bridge.
- When it is no longer needed, all components of the temporary bridge must be removed within three working days, and all exposed erodible soil must be stabilized with mulch, erosion control blankets, or other engineered products designed to prevent erosion and the runoff of suspended sediment into the watercourse/wetland.

7.10.2 Temporary Bridge Construction

Bridge with Runners Founded on a Single Supporting Structure (e.g. square timber)

To construct:

- Place both structural supports parallel to the watercourse, at least 0.5 metre (20 in) landward of the shoulder of the banks of the watercourse. Structural supports should be at least 4 metres (13 ft) long and have a minimum dimension of 25 centimetres (10 in).
- Attach deck timbers that are squared on abutting sides/edges, and spiked in place tightly together, perpendicular to the runners to help make the structure more rigid and to prevent any debris generated from entering the watercourse.
- Place travel planking or wheel runs perpendicular to the deck timbers to protect the deck from wear.
- Maintain the crossing to ensure the material does not build up on the runners/decking, and the stream banks remain stable.

To remove:

- First, clean off the bridge surface.
- Completely remove the structure and all construction materials from the crossing site. If the structural supports are not embedded below grade, they should also be removed.
- All exposed soil must be permanently stabilized with non-invasive perennial vegetation native to the area and blanketed with mulch or blanketed with an engineered erosion control product designed to prevent the generation of suspended sediment due to rain or overland runoff events.

- Use siltation and erosion prevention devices outlined in Section 5.2 *Erosion Prevention and Sedimentation Management* on the approaches to the decommissioned crossing.

Portable Bridges

Portable bridges should not be used for spans exceeding 10 metres (33 ft). These structures may include a prefabricated superstructure consisting of laminated decking (squared on the abutting sides/edges) attached to stringers, flatbed trailers, etc.

To install:

- Establish a structural support abutment, as described in the previous section.
- Lift the portable bridge onto the abutments.

To remove:

See *Bridge with Runners Founded on a Single Supporting Structure (e.g. square timber)* above.

MODULE 8: MAINTENANCE OF ROADS AND WATERCOURSE CROSSINGS TIER REVIEW APPROACH

TIER 1 (5-day review)

- **Culvert maintenance**
- **Bridge maintenance**
- **Culvert or bridge removal (decommissioning)**
- **Vegetation clearing for watercourse crossing installation/replacement**
- **Beaver dam management and removal**

TIER 3 (requires a standard WAWA permit)

- Any alterations resulting in a permanent wetland impact greater than 100 sq. m
- Any alterations in and within 30 m of a provincially significant wetland (PSW)
- Any alterations within a designated [watershed](#) or [wellfield](#) used as a source for public water supply
- Any other activity not approved under Tier 1 or exceeding the guidelines

8.0 MAINTENANCE OF ROADS AND WATERCOURSE CROSSINGS

Maintenance is essential to the ongoing prevention of erosion and sedimentation associated with all aspects of a road system. The objective of maintenance is to ensure that all safety, structural, and environmental protection requirements are being met.

8.1 BASIC STANDARDS

Under the Watercourse Alteration Certification Program, the following standards apply to any maintenance related activities and must be adhered to.

- All instream work must be carried out in isolation of the stream flow. See Section 5.1 *Water Control Measures when Working in a Watercourse* for more details.
- During the repair or replacement of a watercourse crossing structure, preventative measures must be taken to prevent demolition debris, spoil, and excavated material generated by the project from entering a watercourse/wetland
- Culvert maintenance activities must be carried out between June 1st and September 30th of the same year, preferably during low water conditions
- Bridge maintenance requiring the dewatering of a section of the watercourse (i.e. replacement of abutments, etc.) must be carried out between June 1st and September 30th of the same year, preferably during low water conditions
- Excavated materials must be disposed of where they cannot be washed into a watercourse/wetland by floodwaters or surface runoff and any debris generated from the project must be entirely collected and disposed of outside a regulated area, in a manner acceptable to the Department of Environment and Local Government (DELG)

8.2 WATERCOURSE CROSSING STRUCTURES

Problems encountered when inspecting a watercourse crossing should be fixed immediately to prevent any further damage to the aquatic habitat and the fisheries resource. If a problem has been discovered outside of the June 1st to September 30th window, contact DELG for guidance on the next steps.

Maintenance of a watercourse crossing and surrounding areas may require one or more of the following modifications. These modifications are not limited to the circumstances listed below.

- Re-installation/re-construction
 - A structure may need to be re-installed if problems encountered cannot be fixed using other maintenance techniques or where problems continually recur
 - A structure may need to be re-constructed or replaced if it is inadequately sized to pass peak flows or obstructs fish passage

- Stabilization
 - A structure may require stabilization by adding rip-rap, re-vegetating, or implementing other stabilization techniques to stop scour and erosion
- Repair/replace
 - Repair or partial/complete replacement of the structural components of a watercourse crossing structure may be required if defects are encountered
- Removal
 - Obstructions preventing fish passage, threatening the stability, or reducing the discharge capacity of a watercourse crossing structure should be removed

8.2.1 Culvert Maintenance

Culverts should be inspected before and during the seasonal high flow period and following a significant rainfall event. Culverts that are causing ongoing problems should be inspected more frequently until the site is deemed stable and fully serviceable.

During a field inspection, common problem areas which may be encountered are:

- Scouring has occurred rendering the culvert impassable to fish
- Debris, ice, or beaver activity are blocking the inlet to the culvert
- Substrate is absent in the culvert
- Exposed erodible soil areas have not been stabilized around the crossing site or near the watercourse
- Areas around the crossing or near the watercourse are unstable
- The depth of water inside the culvert is insufficient to provide fish passage

Culvert maintenance is required to extend the life of the structure and to ensure that it functions as designed. Culvert maintenance includes the manual or mechanical removal of accumulated debris (e.g. logs, sediment, boulders, debris) that prevents the efficient passage of water and fish through the structure. Culvert maintenance may also include the reinforcement of eroding inlets and outlets.

Under the Watercourse Alteration Certification Program, channel cleaning may occur but must be limited to inside the culvert and the removal of foreign debris deposited between the control riffles. The channel width and depth must not be modified from its natural state, and the control riffles must not be manipulated in any way. All debris/fluvial material removed from the watercourse must be disposed of outside a regulated area, in a manner acceptable to DELG. Any culverts that are cleaned out require a WAWA permit.

Note: All maintenance activities to a culvert, including cleaning it out, require a watercourse and wetland alteration (WAWA) permit.

8.2.2 Bridge Maintenance

Bridges should be inspected frequently to evaluate serviceability and to identify any problems which may threaten the structural integrity of the bridge. Inspections should be carried out frequently, especially during and after peak flows.

Bridge maintenance includes the manual or mechanical removal of accumulated debris (e.g. logs, sediment, boulders, garbage) that prevents the efficient passage of water and fish underneath the structure. It may also include repairs/reinforcement work to an abutment, painting, welding, cement patching, etc.

During a field inspection, common problems which may be encountered include areas where:

- Backwater, flow constriction, and/or increased stream flow velocity is occurring as a result of an inadequately sized bridge
- Scour or erosion has occurred due to the overland runoff and/or improper alignment
- Debris or beaver activity is constricting the waterway opening
- There have been significant changes in the channel upstream or downstream of the structure
- Water is accumulating on the approaches and/or the deck of the bridge
- Components of the bridge are damaged or decayed

Note: Most maintenance activities to a bridge require a watercourse and wetland alteration (WAWA) permit.

8.3 ROAD MAINTENANCE

The purpose of road maintenance is to protect the roadway, maintain runoff control structures, prevent suspended sediment from reaching a watercourse/wetland, and meet road safety standards.

Roadways should be inspected during the seasonal high flow period and following each major rainfall event.

During a field inspection, common problems which may be encountered include areas where:

- The foreslope and backslope of the ditches have become unstable
- Erosion of the roadbed and/or foreslopes has occurred
- Materials such as loose rocks, pieces of wood, or other debris are littering the roadway, creating a hazard
- Erodible soil is exposed along the shoulders of the road

As soon as they are identified, any problems should be fixed to minimize the risk of degradation of the stream flow quality and any danger to road users.

Maintenance practices that include resurfacing and grading of roadways, when necessary, should be established.

8.3.1 Resurfacing the Roadway

Roadways may require resurfacing when there is an insufficient layer of surface material over the sub-base material to allow the roadway to be smooth graded.

The road type normally defines the type of material used in resurfacing. However, on gravel roads, pit run gravel, with sufficient fines, should be used.

Before resurfacing the road, ensure that:

- All drainage control structures are functioning properly
- Ditches are graded properly with no low points that may pond water

Crown and grade the finished road surface to a 3% grade to retain the desired shape of the road.

8.3.2 Grading the Road

Grading is used to reshape unpaved roads to remove ruts, potholes, washboard conditions, and to maintain or re-establish an appropriate crown.

Roads should be graded only when necessary rather than on a regular schedule and should maintain a crown of 3% to drain surface water into the ditch.

Evaluate the road surface to determine whether:

- The surface has washed out, or potholes have begun to form
- The road has become rutted and/or is trapping water

When grading, do not leave a berm or ridge along the edge of the road that prevents water from draining off the road.

Be careful grading near watercourses/wetlands to avoid side-casting material into these features.

Do not push road surface material onto the deck of a bridge.

8.3.3 Brush Maintenance within Right-of-Ways

Maintaining the right-of-way (including fore/back-slopes of roadside ditches) clear from vegetation is an important practice to allow a proper view of the road and any hazards that may be encountered by vehicle traffic. The following guidelines should be used when clearing vegetation within 30 metres (100 ft) of a watercourse/wetland. Provided these guidelines are followed, a WAWA permit is not required.

- Non-merchantable woody vegetation growing within 6 metres (20 ft) of a watercourse/wetland must not be cut or uprooted, unless it presents a significant safety hazard, is infested with insects, or is infected by disease.
- Clearing within 30 metres (100 ft) of a watercourse/wetland must be carried out using hand held equipment only, unless the ground is frozen solid, in which case, machinery may track into these areas (up to 6 metres (20 ft) from a watercourse/wetland).
- Soil disturbance, including grubbing, within 30 metres (100 ft) of a watercourse/wetland must not take place.
- No instream work must take place.
- All slash and woody debris generated during the clearing activity must be disposed of where it cannot be washed into a watercourse by floodwaters. It must either be removed from the floodplain or chipped on-site with the chips directed to areas away from a watercourse or the open water portion of a wetland.
- Vegetation removal/brush maintenance activities are limited to the area within the right-of-way.

Note: The exemption from obtaining a WAWA permit is limited to maintenance clearing along an existing right-of-way. Clearing for new roads and crossings, as well as clearing activities ahead of a crossing installation/replacement is not exempt and requires a WAWA permit. In most cases, these WAWA permits can be applied for under the Watercourse Alteration Certification Program.

8.4 MAINTENANCE OF DRAINAGE CONTROL STRUCTURES

The maintenance of drainage control structures is instrumental in the ongoing diversion of runoff away from watercourses/wetlands.

8.4.1 Roadside Ditches

Roadside ditches should be checked regularly; any obstructions which may impede runoff must be removed.

Re-stabilize areas prone to erosion with non-erodible material or vegetation wherever necessary to stabilize the site.

Pay attention to areas where water is ponding in the ditch. Adjust the ditch grade as required. It may also be necessary to and install additional cross-drainage culverts wherever site conditions permit.

8.4.2 Check Dams

Inspect check dams regularly and following each runoff event to ensure that sediment has not accumulated to a depth of more than half of the height of the check dam. Maintain the retention and discharge capacity of the check dam by removing the accumulated sediment when it reaches half the height of the structure.

Remove check dams when they are no longer needed, and once all erodible soil has become permanently stabilized with vegetation.

Before removing check dams, remove all accumulated sediment and dispose of it where it cannot enter a watercourse/wetland. This should be done whereby:

- Damage to the vegetation in the ditch is minimized
- Flow along the ditch is not interrupted

8.4.3 Hay/Straw Bales and Silt Fences

These types of silt barriers should be checked regularly and immediately following each runoff event and repaired/replaced as needed.

Sediment deposits must be removed when they reach half the height of the barrier.

Replace silt barriers when significant deterioration is evident or when they have reached their expected lifespan.

- Hay/straw bale barriers generally have a lifespan of approximately two months
- Silt fences generally have a lifespan of approximately six months

Any silt fences which has collapsed, torn, or is otherwise ineffective should be replaced within 24 hours of detection.

Remove silt barriers when permanent stabilization of the disturbed area has been accomplished. Smooth grade and stabilize the area where the barrier was located.

8.4.4 Settling Ponds (or Sediment Traps)

Inspect settling ponds regularly to ensure that the level of the sediment accumulated in the pond is 30 centimetres (12 in) below the lip of the outlet. When sediment has accumulated to this level, it must be removed from the pond and disposed of where it cannot be washed into a watercourse/wetland by floodwaters or surface runoff.

Remove any blockage at the outlet to ensure the discharge capacity is not compromised.

When the settling pond is no longer required, pump the detained water into a filter bag or into existing vegetation of sufficient expanse to ensure that there is no visible suspended sediment in the runoff returning to a watercourse/wetland. The pond or trap area should then be filled in and stabilized.

8.4.5 Off-Take Ditches

Inspect off-take ditches regularly to ensure runoff is flowing freely to a densely vegetated area.

Remove any debris from off-take ditches.

Areas where there are signs of channelized flow exiting the ditch other than into the intended densely vegetated area must be repaired and stabilized immediately.

8.4.6 Cross-Drainage Culverts

Inspect cross-drainage culverts regularly to ensure runoff is flowing freely through the culvert.

Remove any debris from the inlet, outlet, and/or inside the culvert, which may obstruct the flow.

Re-stabilize the inlet and outlet using rip-rap where necessary.

8.5 DECOMMISSIONING A ROAD

When decommissioning a road, adhere to the following guidelines.

- Construct water bars across the roadway to deflect and direct overland runoff into erosion-resistant areas. See Section 8.5.1 *Water Bars*.
- In follow-up inspections, repair areas where the runoff has overtopped the water bar. Also, remove any blockage in and at the outlet of the water bar.
- Ensure all drainage control structures are stable and functional.
- Stabilize all areas of exposed erodible soil.
- The approaches to a crossing that has been removed must be blocked off to discourage fording and destabilization of the bed and banks of the watercourse by all-terrain traffic.

8.5.1 Water Bars

Water bars are shallow ditches or channels constructed obliquely across a road surface to intercept runoff and deflect it towards the ditch instead of allowing it to flow further down the surface of the road. They are often associated with the closing or abandonment of a road.

Locate water bars a minimum of 30 metres (100 ft) from watercourses/wetlands.

<u>Slope of the Road (%)</u>	<u>Spacing</u>
< 5	38 m (125 ft)
5-10	30 m (100 ft)
10-20	23 m (75 ft)
20-35	15 m (50 ft)
> 35	7.6 m (25 ft)

Space water bars relative to the slope of the road, as indicated in Table 8-1.

When abandoning a road, construct water bars beginning at the far end of the road and work back towards its junction with an established/active road to prevent machinery from damaging them after they are constructed.

Install water bars at a 30° angle downslope from a line perpendicular to the centerline of the road.

The cross-sectional breadth of a water bar should be 2 to 3 metres (6 to 10 ft). See Figure 8-1.

Excavate a swale approximately 30 centimetres (12 in) deep across the width of the road.

Slope the bottom of the swale 2 to 4% from the inlet side to the outlet side. This allows runoff to readily flow across the road.

Use the material excavated to create the swale to form a 30 centimetres (12 in) high hump across the width of the road.

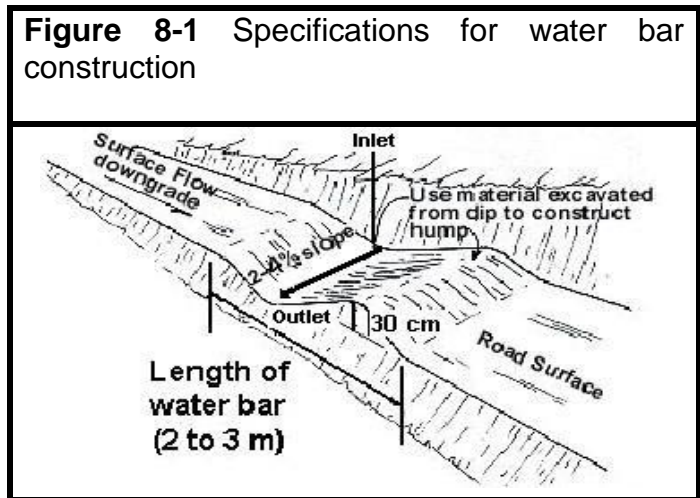

Extend the inlet end of the water bar swale to the invert of the roadside ditch to intercept all the runoff.

8.5.2 Removal of a Culvert

Removal of a culvert must be limited to the period between June 1st and September 30th.

Machinery used to fulfill the project must be located outside of the wetland and the wetted portion of the watercourse.

Fill must not be added and/or new structures must not be constructed to facilitate the project.

The removal of the culvert must be carried out during low stream flow/water level.

The culvert and any associated cover material must be removed, and the channel restored to the cross-section immediately upstream and downstream of the crossing, in isolation of the stream flow.

If you are unable to remove a crossing involving more than one culvert by pumping the stream flow around the worksite, the culverts must be removed per the following sequence:

- First, the culvert on the far side of the channel (the side opposite from where the machinery approaches the project) must be removed in isolation of the stream flow.
- The bank of the watercourse adjacent to this culvert must be restored to the cross-section immediately upstream and downstream of the crossing and permanently stabilized against erosion while all the flow is funnelled through the culvert closest to the other bank.
- As the project progresses toward the near bank, the reclaimed channel must be restored to the cross-section immediately upstream and downstream of the crossing.
- Finally, while the last culvert is being removed and the bank adjacent to it is being restored to the cross-section immediately upstream and downstream of the crossing and permanently stabilized against erosion, the work must be isolated from the stream flow with a cofferdam that constricts the flow to the other side of the watercourse.

The altered area must be restored to its natural grades and/or the channel restored to the cross-section immediately upstream and downstream of the altered area (*i.e.* a reference reach outside of the impacted zone).

The substrate in the new channel should be a mix consisting of rock that mimics what is present naturally in the watercourse or should use reclaimed stream bed material.

The new stream bed mix should have a wide range of particle sized and must include enough silts and fines (particles less than 2 mm in diameter) to fill interstitial spaces and create an impermeable surface. Fines should be washed into the stream bed with a

hose until the water runs clear. If subsurface flow is still evident then more fines and washing may be required.

Small particle sizes are of critical importance for stream bed mixes as a lack of these fines can cause water to flow below the surface of the new channel. It should never be assumed that sediment will be transported from upstream to plug the stream bed as this process could take years.

Woody vegetation removed/cut must be limited to those that are required to facilitate the removal of the culvert.

8.5.3 Removal of a Bridge

Abutments and erosion protection components that are stable, not constricting the stream flow, and composed of durable materials may be left in place. **Note:** Many previously constructed bridge approaches narrowed the watercourse opening through the flood plain and should be removed accordingly.

Completely remove the components of the structure spanning the watercourse. Remember to clean off the decking before the removal.

All work in the wetted portion of the watercourse must be carried out in isolation of the stream flow and must be limited to the time period between June 1st and September 30th.

Machinery used to fulfill the project must be located outside of the wetland and the wetted portion of the watercourse.

The removal of abutments and erosion protection components must be carried out during low stream flow/water level.

The removal of abutments and erosion protection components must be isolated from the stream flow, and any suspended sediment generated must be prevented from causing downstream sedimentation by installing a cofferdam or deploying a silt curtain around the work area that is weighted throughout the bottom (e.g. a chain threaded through it).

The cofferdam/silt curtain must not be removed until all suspended sediment has settled onto the bed of the watercourse.

The altered area must be restored to its natural grades and/or the channel restored to the cross-section immediately upstream and downstream of the altered area.

Woody vegetation removed/cut must be limited to those that are required to facilitate the removal of the structure.

8.6 BEAVER ACTIVITY

Beaver activity becomes increasingly more of a maintenance issue as the development of road systems increases.

Corrective action must only be taken when the impounded water is causing damage to or is an imminent threat of damage to property/infrastructure.

Property damage includes:

- The blockage of a watercourse crossing which results in the flooding and/or erosion of a roadway embankment or surface
- The flooding of properties that are negatively impacting landscaping, septic systems, wells, basements and the utilization of the private properties

When beaver activity is deemed responsible for causing any of the above problems, it must be dealt with in two steps:

- The removal/destruction of the beaver(s) from the impoundment
- The removal of the beaver dam

8.6.1 Removal of Beaver(s)

Beavers may only be removed from an impoundment by a:

- Certified/licensed nuisance wildlife control operator
- A licensed fur harvester

8.6.2 Removal of a Beaver Dam

Beaver dam removal may occur partially or completely depending on the reason for its removal. When fish passage is the issue, partial removal of the dam will often suffice. However, blockage resulting in property damage, flooding, or potential road washout may require the complete removal of the dam.

The removal must make allowance for the gradual release of water to minimize any scouring of the channel and the amount of sediment released downstream.

Under the Watercourse Alteration Certification Program, the following guidelines and general practices must be followed when removing a beaver dam.

In cases where guideline conditions cannot be met, individuals will be required to contact their local DELG office and apply for an emergency permit.

8.6.3 Guidelines

Beaver dams may only be removed/manipulated if the impounded water is causing damage to or is an imminent threat of damage to property/infrastructure. The lowering of the water level shall only be carried out until the risk to property/infrastructure has been minimized.

Non-mechanical (by hand) removal of beaver dams is the preferred method. This method minimizes disturbance to the bed/banks of the watercourse and should be the approach used wherever possible.

Under the Watercourse Alteration Certification Program, beaver dams may only be removed when the work takes place during the ice-free period (normally occurs between May and November). An application for a standard WAWA alteration permit must be made using the [online application program](#) on a site-specific basis to remove beaver dams if ice is present.

Note: A WAWA permit is required for each beaver dam removed or maintained.

8.6.4 General Practices

If machinery can reach the beaver dam from an existing roadway, its removal must be accomplished from the roadway with a hydraulically manipulated bucket or grapple. If machinery cannot reach the beaver dam from an existing roadway, it must not enter a wetland and/or be stationed below the shoulder of the banks of the watercourse to perform the removal; instead, the material must be winched, twitched, or pulled out of the natural channel.

At the first evidence of machinery causing ruts within 30 metres (100 ft) of a watercourse/wetland, the machinery must not advance any further, and the ruts must be immediately smooth graded and blanketed with mulch or slash.

No imported materials must be placed in or within 30 metres (100 ft) of a wetland or within the wetted perimeter of the impoundment to facilitate the removal of the beaver dam.

The removal of the beaver dam must be limited to the material used to build the structure such that the bank and substrate material of the natural channel is not removed/disturbed.

The impounded water must be released over an extended period to minimize silt flushed from the impounded area and reduce the amount of channel erosion downstream due to the increased discharge and flow velocity. Uncontrolled beaver dam removal could result in:

- A flush of sediment that can smother downstream habitats and incubating or emerging fish
- Flooding and erosion of downstream properties
- A rapid reduction in pond depth that can result in stranding and killing species of fish, amphibians, birds as well as aquatic and terrestrial plants
- Scouring and erosion of the downstream channel and banks
- Rapid changes to downstream water temperatures
- Potential contamination of downstream wells

The maximum allowable depth of water spilling over the structure at the drainage point should not exceed 10 centimetres (4 in). The width of the opening created must not exceed the cross-sectional area of the natural channel downstream of the dam. It is recommended that it take a minimum of one day per 0.5 hectare (1.2 acre) of ponded surface area to drain the impoundment.

During the release of the impounded water, the water level upstream and downstream shall be monitored to ensure that there is enough water to support fish and other aquatic habitat. If the water level drops below this threshold, the release of water shall cease immediately and may not commence again until the water level has risen.

The materials removed from the beaver dam must be disposed of where they cannot be washed into the watercourse or wetland by floodwaters.

8.6.5 Chronic Beaver Activity

At sites where beaver activity is continually blocking a closed-bottom culvert, consider replacing the structure with a bridge or open-bottom culvert to discourage this from happening.

MODULE 9: EROSION AND BANK PROTECTION TIER REVIEW APPROACH

TIER 1 (5-day review)

- Placing biotechnical products/vegetation along eroding bank
- Placing rip-rap/armor stone along eroding bank

TIER 3 (requires a standard WAWA permit)

- Any alterations resulting in a permanent wetland impact greater than 100 sq. m
- Any alterations in and within 30 m of a provincially significant wetland (PSW)
- Any alterations within a designated [watershed](#) or [wellfield](#) used as a source for public water supply
- Placing erosion protection products along the banks of a watercourse where an aquatic species (or habitat) at risk has been identified under the [Species at Risk Act](#) (habitat for the Inner Bay of Fundy Salmon and Lake Utopia Rainbow Smelt)
- Any other activity not approved under Tier 1 or exceeding the guidelines

9.0 EROSION AND BANK PROTECTION

9.1 DEFINITION

Erosion protection products (*i.e.* structures or vegetation) are used to stabilize and protect the banks of a watercourse from the scouring and erosive action of water, ice, or floating debris within the stream flow or surface runoff from the land bordering the watercourse.

9.2 OBJECTIVES

- To prevent loss of material from the banks of the watercourse and property adjacent to the banks of the watercourse
- To control channel meander and prevent the undermining of structures
- To prevent sedimentation of the watercourse

9.3 PLANNING CONSIDERATIONS

Natural flowing watercourses meander (*i.e.* have bends – they are not straight). The process of erosion and deposits of materials, such as gravel/sand bars and islands, is a natural process in the evolution of a watercourse. It is natural for bends, riffles, pools, and other features of a watercourse to change in size and location.

The rate and extent of erosion is influenced by the magnitude of the erosive forces from within the watercourse, soil characteristics, topography, and ground cover. The erosion protection products must be designed to modify at least one of these variables.

Taking this information into consideration, it is important to only apply erosion protection products at the appropriate location and to the appropriate degree. Otherwise, the effects can have a significant impact on the system. They may create/accelerate erosion issues to neighboring properties by distributing the energy of the water to a new location.

The inside of a bend is where the channel is shallower, and the flow is slower. This is where deposits (*i.e.* gravel/sand bars) are more likely to form. Unless the watercourse has been artificially disturbed, there is no erosion at this location. Applying erosion protection products at the inside of a bend will significantly disturb the natural flow of the watercourse and could cause additional problems downstream, creating a domino effect. Erosion naturally occurs on the outside bend of a flowing watercourse. This is also where the flow is fastest, and the channel is deepest, creating pools for fish to rest and cool down.

Note: The installation and placement of erosion protection products on the bank of a watercourse is only permitted if there is erosion present on the bank that could

compromise existing infrastructure or the loss of land. If there is no erosion, the application will be refused.

Erosion and bank protection projects where there is an aquatic species at risk under the [Species at Risk Act](#) that is subject to the DFO Critical Habitat Order require a standard WAWA permit. These areas include the habitat for the Inner Bay of Fundy Salmon and Lake Utopia Rainbow Smelt. For these instances, an application for a standard watercourse and wetland alteration permit must be made using the [online application program](#).

9.4 COMMON PRODUCTS USED FOR EROSION PROTECTION

9.4.1 Vegetation

Can be in the form of grasses, shrubs, trees, vines, and live cuttings. It can also include live fascine (wattles), live stakes, and brush mattresses. A combination of a rock toe with vegetation above this layer is also an option.

9.4.2 Structural Products

Rip-rap/armor stone

The placement of a layer of boulders, cobbles, or rock fragments placed over an exposed slope.

Retaining walls

They are constructed out of wire baskets or cages filled with rock or timber crib, steel, or concrete. **Note:** Although mentioned here as a structural product, the construction of retaining walls is not permitted under the permitting system within the Watercourse Alteration Certification Program. A standard WAWA permit is required for all retaining walls.

9.4.3 Choosing an Erosion Protection Product

The method used depends on the magnitude of the erosive forces and economic feasibility. Vegetation and rip-rap are the least expensive alternatives. However, they may not be applicable if the banks are excessively steep or the wave/ice action is excessive or if the soils, such as sand or heavy clay, do not allow vegetation to become established.

Other types of erosion protection products should be avoided if vegetation can be used, or they should be used in combination with vegetation wherever possible. The shade provided by the vegetation helps prevent rip-rap, and the stones used in the rock-filled wire baskets from heating up, which in turn helps reduce thermal pollution of the water.

Vegetation also provides food and cover for aquatic animals and wildlife. Mulch, consisting of plant residue or synthetic materials, is often used to temporarily protect the work site from erosive forces of rainfall and to aid in the germination and growth of vegetation until the vegetation becomes well established or the site is permanently stabilized by another means. It can be used in combination with vegetation providing temporary protection to denuded slopes during the early phases of plant growth or can be used alone during the non-growing season where plant growth is impossible. Mulch improves water infiltration, reduces rainfall impact, and reduces surface runoff. Materials commonly used as mulch include straw, hay, corn stalks, wood or bark chips, soil binders, nets, and mats. Chemical mulches, consisting of emulsions of vinyl compounds, rubber or other substances, are mixed with water and then sprayed on the exposed soil.

All techniques require that the upstream and downstream limits of the erosion protection product be keyed into the bank to prevent scouring around either end.

9.5 BIOTECHNICAL/VEGETATION

9.5.1 Definition

The placement of biotechnical products, along with trees, shrubs, vines, grasses, cuttings, or other plants used to stabilize and protect the banks of a watercourse from the erosive action of the stream flow, waves, ice, and debris within the watercourse.

It also includes live fascine (wattles), live stakes, and brush mattresses. A combination of a rock toe with vegetation above this layer is also an option. See Figure 9.1.

When erosion is occurring, vegetation should be the first option to consider while easing the steepness of the bank and creating a vegetated floodplain to disseminate the water flow and its energy. Instead of trying to stop the water from entering the land, the focus should be shifted to allowing the water to flow to its natural path while protecting existing infrastructure.

9.5.2 Objectives

To protect the banks of a watercourse while providing and promoting habitat for fish and wildlife.

To minimize the thermal pollution of the water.

Figure 9-1 Live fascine (wattles), live stakes, and brush mattresses

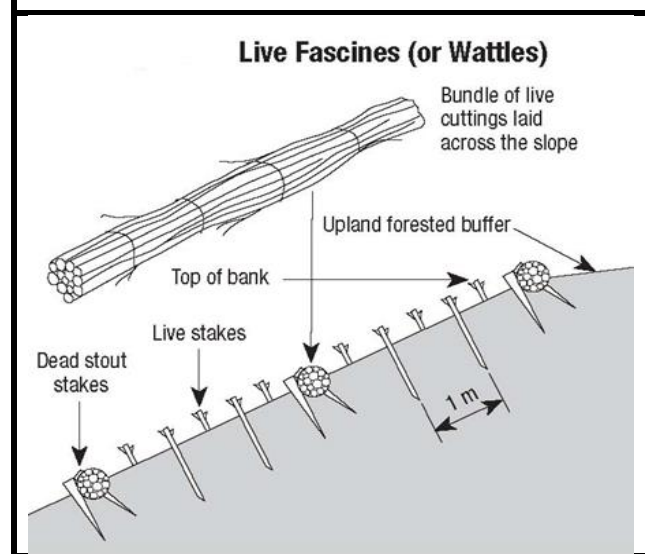

9.5.3 Planning Considerations

If the banks are made up of soil which can sustain plant growth and have slopes of 2:1 or flatter, vegetation provides excellent protection against soil erosion. It also promotes animal habitat along the banks of the watercourse and in the water by providing shade and by depositing leaf litter and insects into the water, which act as food sources for fish and aquatic insects.

The degree of erosion protection offered by vegetation and vegetative products increases as the plants and root systems grow and spread. Advantages of using vegetation as an erosion protection product include the following:

- Vegetation shields the soil from raindrop impact and slows the velocity of runoff, thereby protecting the watercourse from sedimentation
- The root systems hold soil particles in place and maintain the soil's capacity to absorb water
- It is less costly than other product and requires little or no maintenance
- Vegetation is more compatible with the natural watercourse characteristics
- It helps maintain a lower water temperature and provides cover for the fish in the water and wildlife on the shoreline

9.5.4 Guidelines

Plants chosen for erosion protection should require little maintenance and be suited for the climate and soils at the site. Conditions throughout the province vary greatly and plans for vegetative stabilization must be adapted on a site-specific basis. In general, the plants should have fibrous roots and be capable of attaining dense growth, thereby providing a complete soil cover. The selected species should be easy to plant, fast-growing, requiring little or no irrigation, fertilizer, or mowing. Examples of plants used for vegetative stabilization include alders, willows, poplars, shrub willow, shrub dogwood, lupine, clover, timothy, and trefoil. A local nursery can be consulted for species of plants that are adapted to specific conditions.

Many types of plants are used for vegetative stabilization in New Brunswick. Species of grasses, legumes, vines, shrubs, or trees are used depending on slope stability, soil type, and moisture conditions. Only non-invasive plant species native to New Brunswick are to be used for stabilization purposes.

A variety of species should be planted rather than a single species of plant. The vegetation should be checked and maintained on a regular basis until growth is established. The plants may have to be watered and fertilized to promote growth initially.

The portion of the bank of the watercourse where biotechnical products are to be placed shall be uniformly graded to a slope no steeper than 2 horizontal to 1 vertical. Clean, well-graded borrow may be added if required to obtain a uniform slope. The reshaping

of the eroding bank to a stable slope and any placement of material to create a uniform slope must be carried out in isolation from the remainder of the watercourse.

The height of the erosion protection material must not be any greater than the existing grade of the top of the bank as it exists immediately upstream and downstream of the project area. In other words, the grade of the property cannot be raised as a result of the project, and the addition of the material must not create a berm.

The placement of the biotechnical products shall start at the upstream end of the eroding section of the bank and progress in the downstream direction. The upstream and downstream limits of the products shall be keyed into the bank to prevent scouring around either end.

Biotechnical products placed for the protection of agricultural land shall include establishing and maintaining a buffer of undisturbed vegetation at least 5 metres (16.4 ft) wide along the upland edge of the stabilized bank.

Note: If the proposed project does not meet these guidelines, an application for a standard watercourse and wetland alteration permit must be made using the [online application program](#). During the permit application review process, DELG may require that the project be designed (signed and stamped) by a professional engineer licensed to practice in the province of New Brunswick.

9.6 RIP-RAP

9.6.1 Definition

Rip-rap is heavy broken rock, cobbles, or boulders placed over a denuded or exposed soil, providing a permanent, erosion-resistant cover. See Figure 9-2. Rip-rap is used to armor the banks of watercourses for the following reasons:

- To protect the banks and adjacent upland areas from the erosive action of the stream flow, waves, ice, or floating debris
- To control channel meander thereby protecting downstream or adjacent facilities or resources
- To protect the banks near a bridge or culvert where erosion could undermine the structure
- Existing infrastructure may be too close to the bank of the watercourse, therefore creating a vegetated floodplain may not be a suitable option

Figure 9-2 Bank stabilization using rip-rap

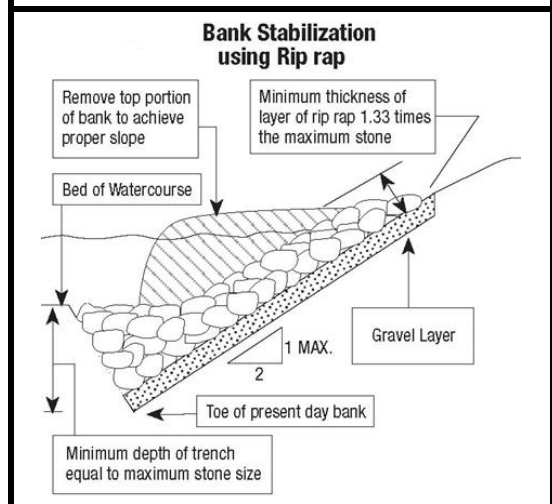

9.6.2 Planning Considerations

Rip-rap can be used to prevent erosion on the bank of a watercourse if it is no steeper than 2:1 and if the velocity of the flowing water prevents the use of vegetation. Rip-rap depends on the soil beneath it for support; therefore, it must be founded on solid ground. If the banks are unstable, crumbling, excessively steep or vertical, rock-filled wire baskets or retaining walls may need to be used to maintain the property bordering the watercourse. Otherwise, the top of the bank may be cut-back/contoured to achieve the slope prescribed above.

Rip-rap is often placed as a rock apron on the bed/bank of the watercourse at the discharge of an outfall pipe, around bridge abutments and piers to prevent scour, and around the ends of a culvert to help prevent erosion of the foreslopes.

9.6.3 Environmental Considerations

Rocks used as rip-rap can heat up from the sun, which may result in an increase in water temperature, and consequently, a decrease in dissolved oxygen required for fish.

9.6.4 Construction

The sequence for construction includes uniformly grading the surface of the banks, followed by placement of the rip-rap. In standing water environments, placement of a filter layer, such as geotechnical fabric and/or a layer of clean gravel, may be used.

9.6.5 Guidelines

Rip-rap/armor stone must be clean, durable, non-ore bearing, and non-toxic rock, and must not be obtained from a watercourse nor from within 30 metres (100 ft) of a watercourse/wetland.

Rocks used to stabilize the bank of the watercourse must be irregular in shape, with at least 70% of the material having a smallest dimension of not less than 15 centimetres (6 in).

The minimum thickness of the layer of rip-rap/armor stone must be 1.33 times the maximum rock size used.

The full thickness of the rip-rap/armor stone must be deposited as a dense mass of various sized rock with minimal voids. It shall not be placed in layers.

The rip-rap/armor stone must not be dumped or pushed over the shoulder of the bank but either lowered in place with machinery capable of controlling the dropping of the rock or placed into position using machinery stationed on a barge.

Trees and other woody vegetation removed must be limited to the minimum required to facilitate the stabilization of the bank of the watercourse. Any vegetation destroyed, including trees removed, to fulfill the project must be replaced with non-invasive perennial vegetation native to the area. The species and density of woody vegetation planted shall be similar to that which existed in the area before the project took place.

The height of the erosion protection material must not be any greater than the existing grade of the top of the bank as it exists immediately upstream and downstream of the project area. In other words, the grade of the property cannot be raised as a result of the project, and the addition of the rip-rap/armor stone must not create a berm.

The base of the rip-rap/armor stone must follow the alignment and be entrenched at the toe of the present-day bank of the watercourse created by the effects of the erosion.

While carrying out maintenance work to the existing rip-rap/armor stone, the existing base of the rock wall must be entrenched at the toe of the present-day bank of the watercourse created by the effects of the erosion if it is not currently entrenched. Furthermore, additional rip-rap/armor stone must not be placed any closer to the watercourse than the present-day bank.

The portion of the bank where rip-rap/armor stone is to be placed must be uniformly graded to a slope no steeper than 2 horizontal to 1 vertical. Clean, well-graded borrow may be added where needed and compacted to prepare a uniform base for the rip-rap/armor stone. The reshaping of the eroding bank to a stable slope and any placement of material to create a uniform slope must be carried out in isolation from the remainder of the watercourse.

A layer of clean, coarse gravel must be placed under the rip-rap/armor stone. If geotextile fabric is used, it must be pulled flat to eliminate wrinkles and folds which create voids.

The placement of the rip-rap/armor stone must start at the upstream end of the eroding section of the bank and progress in a downstream direction. The upstream and downstream limits of the products must be keyed into the bank to prevent scouring around either end.

Once the rip-rap/armor stone is installed, it requires minimal maintenance. Still, it should be checked periodically to ensure that any movement of the stones does not result in exposing the slope, increasing the risk of failure.

Rip-rap/armor stone placed for the protection of agricultural land must include establishing and maintaining a buffer of undisturbed vegetation at least 5 metres (16.4 ft) wide along the upland edge of the stabilized bank.

Note: If the proposed project does not meet these guidelines, an application for a standard watercourse and wetland alteration permit must be made using the online application program. During the standard permit application, DELG may require that the project be designed (signed and stamped) by a professional engineer licensed to practice in the province of New Brunswick.

9.7 TIMING OF INSTALLATION

All erosion and bank protection projects must be carried out between June 1st and September 30th of the same year, preferably during low water conditions. Construction should proceed diligently to help minimize any unnecessary environmental problems and minimize impacts to fish.

Work and project extensions outside of this window will not be approved through the Watercourse Alteration Certification Program. If there are unforeseen issues that prevent the project from being completed prior to the September 30th deadline, DELG should be contacted as soon as possible to discuss next steps.

MODULE 10: TIMBER HARVESTING TIER REVIEW APPROACH

TIER 1 (5-day review)

- **Timber harvesting within 30 m of watercourses and non-forested wetlands** (max 30%; carried out either by a uniform selection of trees or by harvesting evenly spaced strips)
- **Timber harvesting in and within 30 m of forested wetlands** (removal of all merchantable timber)

TIER 3 (requires a standard WAWA permit)

- Any alterations in and within 30 m of a provincially significant wetland (PSW)
- Any alterations within a designated [watershed](#) or [wellfield](#) used as a source for public water supply
- Any other activity not approved under Tier 1 or exceeding the guidelines

10.0 TIMBER HARVESTING

10.1 DEFINITIONS

Timber harvesting is the harvesting or felling of merchantable timber within 30 metres (100 ft) of a watercourse/wetland. This does not include the removal of trees of undesired vegetation for the purpose of viewing, watercourse access, or brush maintenance within right-of-way of existing roadways. See Section 8.3.3 *Brush Maintenance within Right-of-Way* for more information on this activity.

Merchantable timber is defined as woody vegetation equal to or greater than 10 centimetres (4 in) in diameter at breast height (1.3 metres (4.3 ft) above ground).

Forested wetlands are areas where the water table is at or near the surface, soil conditions are water-saturated, or standing water is present with at least 30% of the surface area covered by woody vegetation greater than 6 metres (20 ft) in height that is at least partially rooted within the wetland. Examples of forested wetlands include red maple swamps, cedar swamps, and black spruce swamps.

Note: All merchantable timber may be removed from a forested wetland.

10.2 OBJECTIVES

To maintain a viable buffer by controlling activities within 30 metres (100 ft) of a watercourse or wetland to:

- Maintain and promote healthy aquatic habitat
- Prevent sedimentation of the watercourse
- Ensure bank stability
- Minimize disturbance to terrestrial habitats

10.3 PLANNING CONSIDERATIONS

To maintain the protection offered to our watercourses and wetlands by a natural buffer zone of vegetation in forests, harvesting activities are limited within 30 metres (100 ft) of watercourses/wetlands.

Selective harvesting involves harvesting a percentage of the merchantable trees. The total merchantable trees removed from the 30 metre (100 ft) buffer area is typically limited to 30%. This harvest may be carried out either by a uniform selection of trees or by harvesting evenly spaced strips and is limited to the same area once every 10 years (with a valid permit). The harvesting activity must not present a threat to stand viability.

10.4 ENVIRONMENTAL CONSIDERATIONS

An adequate buffer zone of vegetation maintained along a watercourse will protect the riparian zone, which is the area of vegetation bordering a watercourse. The benefits of a healthy riparian zone are listed below:

Food supply - Insects and organic debris dropping from the vegetation provide food sources for wildlife and aquatic species.

Shelter - Vegetation along the banks of a watercourse provides protection to wildlife inhabiting the vegetated zone adjacent to the watercourse. The shelter provides wildlife with secure cover to gain access to the water throughout the year and migration corridors along watercourses.

Shade - Vegetation shades the water from direct sunlight, thereby controlling water temperature and preventing excessive fluctuations. By keeping the temperatures cool, the dissolved oxygen content in the water is maintained.

Filter - The vegetation and root systems effectively filter and help purify the upland surface runoff by slowing it down and by allowing sediments to settle out or by acting as a filter, thus preventing suspended sediments and pollutants from entering the watercourse.

Erosion control and stability - Root systems bind soil particles in place, thus preventing slope failure and erosion of the watercourse banks, which in turn helps preserve channel stability.

The amount of stormwater runoff is decreased by leaves that intercept rain and transpire water. Root systems increase the soil's ability to absorb water. These two factors combine to reduce the amount of surface runoff, prevent sedimentation of the watercourse, and reduce soil moisture content that can prevent bank failure from occurring.

10.5 ACTIVITIES ASSOCIATED WITH TIMBER HARVESTING

Riparian zone vegetation, aquatic habitat, and water quality can be severely impacted by the following timber harvesting activities:

- **Clear cutting** increases the amount of runoff and sediment entering a watercourse/wetland by reducing the vegetative canopy, exposing bare soil, and allowing increased snow deposition. Clear cutting can also introduce more debris into the water which may block the watercourse creating barriers to fish passage or causing channel shifts. Clear cutting is not permitted within 30 metres (100 ft) of a watercourse/non-forested wetland under the Watercourse Alteration Certification Program.
- **Construction of landings and loading areas** is not permitted within wetlands (forested and non-forested). These areas are used to stack timber until they are transported and can develop relatively hard, impermeable surfaces decreasing the

amount of water percolating through the soil. Landings and loading areas are not permitted within 15 metres (50 ft) of watercourses/non-forested wetlands. Landings and loading areas within 30 metres (100 ft) of watercourses/non-forested wetlands should be located close to the road and on firm, high ground where possible to avoid rutting and blockage of drainage paths.

- **Skidding or twitching** cut trees has the potential to destroy the immature vegetation, compact the soil and make large ruts in the ground surface, creating conditions that cause erosion and sedimentation.
- **Use of machinery**, such as skidders and porters, is not permitted within 15 metres (50 ft) of watercourses/non-forested wetlands unless the machinery is constructing or travelling on an access road which extends across the watercourse. See Section 7.10 *Temporary Bridges*. This will prevent negative impacts of machinery on the stem, limbs, and roots of the buffer zone vegetation. It will also avoid soil compaction, rutting, and decrease the possibility of debris entering the watercourse.

10.6 HARVESTING

To ensure that an adequate buffer area is maintained, timber harvesting must be limited to 30% of the merchantable trees within 30 metres (100 ft) of watercourses/non-forested wetlands. This harvest may be carried out either by a uniform selection of trees or by harvesting evenly spaced strips and is limited to the same area once every 10 years (with a valid permit). **Note:** All merchantable timber may be removed from a forested wetland.

10.7 GUIDELINES

The 15 metre (50 ft) and 30 metre (100 ft) wide buffer bordering watercourses and non-forested wetlands must be clearly delineated in the field or with an "on-board" GPS prior to commencing harvesting operations. The presence of forested wetlands shall also be identified in the field or with an "on-board" GPS system prior to commencing harvesting operations.

Machinery must not track within 15 metres (50 ft) of a watercourse/non-forested wetland.

Machinery must not track within 30 metre (100 ft) of a watercourse/non-forested wetland on slopes greater than 40%. On slopes greater than 25% but less than 40%, harvesting can occur using one of the following methods: (a) harvesting must be performed using a "cut-to-length" criterion whereby both the harvester and forwarder may only travel on trails covered by a brush mat of tops and branches provided by the harvester, or; (b) harvesting and forwarding must occur under frozen conditions.

Grubbing must not take place in a non-forested wetland nor within 30 metres (100 ft) of a watercourse/non-forested wetland.

Within 30 metres (100 ft) of a watercourse/non-forested wetland, at the first evidence of machinery cutting through the duff layer to mineral soil deeper than 15 centimetres (6 in) and longer than 4 metres (13 ft), the machinery must exit the 30 metre (100 ft) buffer, and the rut must be immediately smooth graded and blanketed with mulch, slash, and/or brush mats. Machinery may only advance beyond this point on pre-fabricated/engineered swamp mats which must be removed as the machinery leaves the area, brush mats, or when the ground is frozen solid.

Within forested wetlands, at the first evidence of machinery cutting through the duff layer to mineral soil deeper than 15 centimetres and longer than 4 metres, the machinery shall exit the 30-metre buffer and the rut shall be immediately smooth graded and blanketed with mulch, slash, and/or brush mat. Machinery may only advance beyond this point on pre-fabricated/engineered swamp mats which shall be removed as the machinery leaves the area, brush mats, or when the ground is frozen solid unless the permittee has a “best management plan” which addresses rutting risk in forested wetlands. Any “best management plan” shall be reviewed and approved by DELG.

No more than 30% of the merchantable trees within 30 metres (100 ft) of a watercourse/non-forested wetland must be harvested from the same area once every ten years (with a valid permit). This harvest may be carried out either by a uniform selection of trees or by harvesting evenly spaced strips. The amount and type of trees that may be harvested shall be determined as follows: a) both merchantable blowdowns and live trees shall be included when determining the total number of trees to be taken; b) all merchantable blowdowns on the site shall be selected for removal before any live trees are harvested; c) if the number of merchantable blowdowns is greater than 30% of the number of merchantable trees on site, all of the blowdowns may be removed, but no live trees shall be cut.

Trees overhanging or rooted below the shoulder of the bank of a watercourse must not be harvested.

No woody vegetation (e.g. alders, bushes, or trees) smaller than market size must be intentionally cut or uprooted in a non-forested wetland or within 30 metres (100 ft) of a watercourse/non-forested wetland unless considered hazardous or located in the footprint of the forest access trails.

Trees must not be felled into or across a watercourse or the open water portion of a non-forested wetland.

Harvested timber must not be stacked in a non-forested wetland or within 15 metres (50 ft) of the shoulder of the bank of a watercourse.

All slash and woody debris generated by the project must be removed and disposed of such that it cannot enter a watercourse or open water portion of a non-forested wetland and be washed downstream by floodwaters or high flows.

MODULE 11: WATER INTAKE STRUCTURES TIER REVIEW APPROACH

TIER 1 (5-day review)

- **Temporary withdrawal of water using an above ground intake pipe** (max rate of 10 L/min for every sq. km upstream intake point)
- **Replacing or maintaining an existing permanent water intake structure** (e.g. pumping station, dry hydrant)

TIER 3 (requires a standard WAWA permit)

- Water withdrawal from a wetland
- Any alterations resulting in a permanent wetland impact greater than 100 sq. m
- Any alterations in and within 30 m of a provincially significant wetland (PSW)
- Any alterations within a designated [watershed](#) or [wellfield](#) used as a source for public water supply
- Any other activity not approved under Tiers 1 or exceeding the guidelines

11.0 WATER INTAKE STRUCTURES

11.1 DEFINITION

Structures used to withdraw water from a watercourse for the purpose of irrigation, domestic supply, manufacturing, firefighting, aquaculture facilities, or other uses.

11.2 OBJECTIVES

While withdrawing water from a watercourse, the following precautions should be taken.

- The volume of water withdrawn must maintain sufficient flow and depth of water in the watercourse to ensure that fish habitat is protected, and fish passage is maintained
- Downstream water quality must be maintained
- Care must be taken to minimize disturbances to the bed and banks of the watercourse during the maintenance or replacement of a permanent water intake structure (*i.e.* dry hydrant, pumping station)

11.3 WATER WITHDRAWAL WITHIN CERTIFICATION

Under the Watercourse Alteration Certification Program, the following is permitted:

- The extension, replacement, or maintenance of an existing water intake structure (e.g. pumping station, dry hydrant) provided there is no increase in the rate of water withdrawal
- Temporary water withdrawal from a watercourse using an above ground intake hose/pipe or filling a bulk water tank for various purposes (e.g. dust control, concrete/asphalt curing, hydroseeding, etc.), provided the maximum withdrawal rate does not exceed 10 litres/minute for every square kilometre of drainage area upstream of the withdrawal point, except in emergency situations when the water is being drawn for firefighting purposes

11.3.1 Dry Hydrants

Dry hydrants are water intake structures consisting of a standpipe buried in the bank of a watercourse with a horizontal pipe connected to the bottom end, which extends into the

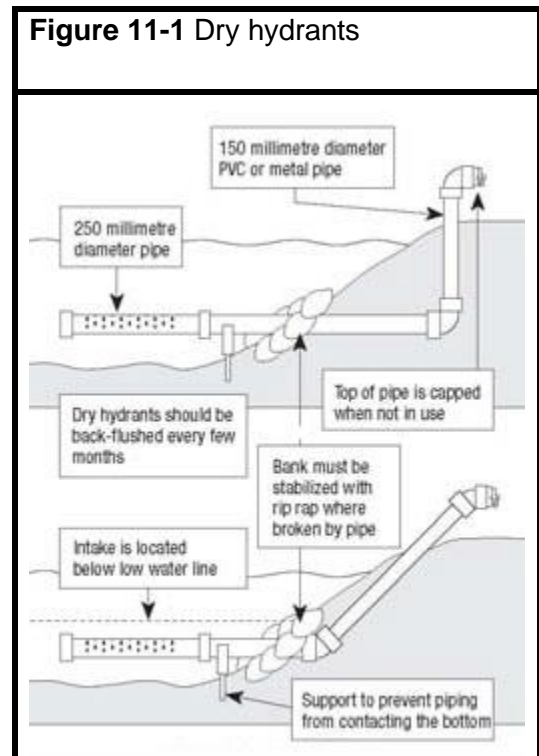

watercourse. See Figure 11-1. The end of the pipe must be screened in accordance with the specifications outlined for all water intake structures (see Section 11.4.1 *Environmental Considerations*). The structure is subject to all rules and regulations governing water intake structures. Water is withdrawn from a dry hydrant on an 'as needed' basis by a mobile pump carried on a fire truck.

11.4 PLANNING CONSIDERATIONS

11.4.1 Environmental Considerations

Whether the water is withdrawn from a flowing watercourse such as a stream, creek, river, or brook, or a standing body of water such as a lake or a pond, the following concerns must be addressed before the project begins:

- The water withdrawal must not cause any fish or other aquatic organisms to be removed from their habitat. The intake must be screened to prevent these organisms from entering the structure. For more information, please refer to the Fisheries and Oceans Canada's Code of Practice for End-of-Pipe fish protection screens for small water intakes in fresh water: <https://www.dfo-mpo.gc.ca/pnw-ppe/codes/screen-ecran-eng.html>.
- The volume of water remaining in the watercourse must be adequate for the maintenance of aquatic habitat and fish passage. Decreasing the volume of water in a watercourse may result in an increase in temperature, making it intolerable for some species of fish. A decrease in water level or flow can also diminish suitable living space for fish, reduce the habitat and production and delivery of food organisms and accelerate sediment deposition.
 - If the depth of water is decreased, it may pose a barrier to fish passage. Depth of water required by fish for swimming varies, but on average, 15 to 23 centimetres (6 to 9 in) are considered the minimum depth of water required.
- Water intake structures must be installed so that they do not present an obstruction to migrating fish. Permanent structure installed must not destroy fish habitat. Any bed or bank disturbance caused by installation must be stabilized immediately to prevent the sedimentation of the watercourse, which could negatively impact fish habitat.
- The quality of the water at the site and downstream of the site must be maintained during and after water withdrawal.

11.4.2 Water Requirements

Determination of allowable pumping or water withdrawal rates must consider the time period for which the water is needed. Many irrigation projects require water during dry seasons, during which the required maintenance flow may not allow for the removal of any water. In these cases, planning should include a reservoir to be filled during periods of higher flows.

If the water is to be withdrawn on a continuous basis, for example, in a fish hatchery, a calculation of the low flows expected for the watercourse at the point of withdrawal would be useful to predict whether the maintenance flows allow for any water removal during the low flow period.

11.5 GUIDELINES

The following guidelines should be followed during the extension, replacement, or maintenance of an existing water intake structure (e.g. pumping station, dry hydrant) or the establishment of a temporary water withdrawal system (e.g. using an above ground intake hose/pipe or filling a bulk water tank for various purposes).

- If instream excavation is required to create a sump to facilitate water extraction, it must be strictly carried out manually using handheld equipment and be carried out between June 1st and September 30th only.
- Water withdrawal is not permitted in a wetland under the Watercourse Alteration Certification Program.
- During temporary water withdrawal, the intake hose/pipe must remain above ground. Soil disturbance must not be carried out to facilitate this activity.
- The water intake must be constructed with bed and bank reinforcement to adequately protect the watercourse and intake works from local erosion.
- Permanent water intake structures must be secured and protected from ice and floating debris.
- The water intake structure must not pose a hazard to navigation.
- The intake of the suction hose and any water intake or outlet pipes must be screened to prevent aquatic organisms from entering the structure. For more information, please refer to the Fisheries and Oceans Canada's Code of Practice for End-of-Pipe fish protection screens for small water intakes in fresh water: <https://www.dfo-mpo.gc.ca/pnw-ppe/codes/screen-ecran-eng.html>.
- The maximum withdrawal rate must not exceed 10 litres/minute for every square kilometre of drainage upstream of the inlet, except when the water is being used for firefighting purposes.
- During low water conditions, the water level of the watercourse must be monitored to ensure that there is enough water for fish to swim. If the water level drops, water withdrawal shall cease immediately and may not commence again until the water level has risen.
- Any disturbance to the banks or bed caused by the installation, replacement, or maintenance of a water intake structure must be immediately stabilized to prevent sedimentation of the watercourse.

12.0 GLOSSARY OF TERMS

Abutment: a wall or mass supporting the end of a bridge, span, or open-bottom culvert and sustaining the pressure of the abutting earth

Alignment: the fixing of points on the ground for the laying out of a culvert, bridge, abutment or pier

Arch: a curved structure designed to exert horizontal forces on its supports when subjected to vertical loads; commonly used as a bridge or support for a roadway or railroad track

Armor rock: natural, angular quarry stone, which has been chosen for its durability and resistance to wear and erosion; normally produced from blasting operations

Aquatic: living or growing in, on or near water; aquatic life refers to organisms that live in water and can include fish, invertebrates, and shellfish

Backfill: fill used to replace material removed during construction of a structure such as a bridge or culvert

Backslope: slope between the bottom of the ditch and original ground

Baffle: a barrier or obstruction that deflects, checks, or dampens water flow

Bank: any elevated slope of earth that borders a body of water, especially the rising ground that confines a watercourse to its channel bank

Bed: the ground beneath a body of water

Bed load: soil particles carried by the natural flow of a watercourse on or immediately above its bed

Berm: a small dyke

Benching: a technique of grading or placement of fill to create a series of level benches or steps on a slope

Borrow area: excavated material along the road right-of-way or from precut pits outside the road right-of-way to be used in the subgrade or grade of the road

Box Culvert: a culvert of rectangular or square cross-section

Bridge: a structure built over a watercourse, the deck of which forms a link in the road, footpath, or railbed

Brush: a thick growth of shrubs, bushes, small trees, and other non-merchantable woody vegetation

Bullpen: a flattened soil covered, bulldozed ramp of grubbed material located in natural or precut openings adjacent to the road right-of-way

Camber: to curve upward or slightly rise near the middle; culverts are cambered so that upon settlement of the roadbed, they take on a more or less uniform slope

Channel: the open depression in which water may or does flow; the space above the bed and between the banks of a watercourse

Check dam: a low fixed structure constructed of hay bales, timber, or loose rock to control water flow in an erodible channel or ditch

Cobble: somewhat rounded rock fragments larger than gravel and smaller than boulders ranging in size from 100-200 millimetres

Cofferdam: a temporary structure constructed around an excavation to exclude water so that work in or adjacent to a watercourse can be carried out in isolation of stream flow

Confluence: the place where two or more watercourses come together

Constriction: narrowing of a channel to less than its normal or average width as a result of human-made or natural slide controls

Culvert: a covered structure which conveys the flow of water in a watercourse under a roadway whereby the top of the cover material is graded to form the travel surface

Discharge: the flow rate of a fluid at a given point in time expressed as volume per unit of time, such as cubic metres per second, gallons per minute, etc.

Dissolved oxygen: the concentration of oxygen dissolved in the water, expressed as mg/L or the percent saturation, where saturation is the maximum amount of oxygen that can theoretically be dissolved in water at a given altitude and temperature

Downstream: in the direction of the normal flow of a watercourse

Drainage area: the area of land drained by a watercourse

Dyke: an impervious embankment constructed along the bank of a watercourse to prevent the overflow of water onto lowlands and to retain floodwaters

Erosion: the loosening, wearing away and transportation from one place to another of materials from the earth's surface by the action of wind, water, and ice

Erosion control work (or erosion protection products): structures or vegetation used to stabilize and protect the banks of a watercourse from the scouring and erosive action of water, ice or floating debris within the stream flow or surface runoff from the land bordering the watercourse

Filter: a device or porous structure through which a liquid is passed to remove solids or impurities

Fish/construction/work window: the period of time from June 1st to September 30th in which instream work is typically permitted

Flood plain: flat land bordering a watercourse which is subject to flooding

Fluvial: pertaining to or produced by the water flow in a watercourse

Foreslope: slope between the road shoulder to the bottom of the ditch or base of slope where there is no ditch

Gabion: wire baskets filled with coarse gravel or rock used especially to support the bank of a watercourse or an abutment

Grade: the slope of a roadway, ditch, or bed of a watercourse expressed as a function of the amount of vertical drop over a given distance; also to prepare a roadway or other land surface of uniform slope

Gravel: rounded pebbles larger than sand and smaller than cobble ranging in diameter from 5-15 millimetres

Grubbing: removal and disposal of stumps, roots, brush, and small trees

Habitat: fish habitat is defined in the federal *Fisheries Act* as water frequented by fish and any other areas on which fish depend directly or indirectly to carry out their life processes, including spawning grounds and nursery, rearing, food supply and migration areas

Headwall: a retaining wall at the inlet/outlet of a culvert serving as protection against scouring and erosion of the foreslope

Hydraulic: pertaining to fluid in motion and the mechanics of that motion

Hyperventilation: condition of breathing excessively

Impervious: not permitting water or other fluid to pass through

In isolation of stream flow: separated from the wetted portion of the channel

Interstitial: small narrow spaces between substrate

Inert: having no inherent power of action, motion, or resistance

Invert: the floor or bottom of a pipe, pipe arch or artificial channel

Landing stage: any place where round timber is stacked for further transport

Littoral zone: the near-shore section of water where light penetrates to the bottom; these zones are often highly productive because the penetration of light initiates primary food production

Maintenance flow: the quantity of flow prescribed by regulation or guidelines to be retained in a watercourse downstream of a point of withdrawal required to maintain the integrity of the aquatic ecosystem or to meet downstream water demands

Maximum design velocity: the maximum flow velocity a bridge or open-bottom culvert can withstand and not reduce the life of the structure

Meanders: a series of bends, loops or curves in a watercourse formed by the action of flowing water

Merchantable trees: any softwood tree at least 12.7 centimetres in diameter at breast height; any hardwood tree at least 7.6 centimetres in diameter at breast height

Mulch: a protective covering, such as hay or straw that is spread over exposed soil to prevent erosion and evaporation, maintain an even soil temperature, control weeds, and enrich the soil

Obstruction: watercourse alterations which involve the construction of structures on the watercourse, impeding or preventing the flow of water/fish migration

Open-bottom culvert: semi-circle, rectangular or elliptical corrugated metal, concrete, wooden or plastic arch founded on footings, with the sides and top encased in earth fill, designed to carry water under a travel surface

Ordinary high water mark: the visible high water mark of a watercourse where the presence and action of water are so usual and so long continued in ordinary years as to mark upon the bed a character distinct from that of the bank thereof with respect to vegetation and the nature of the soil

Peak: maximum instantaneous stage or discharge of a watercourse in flood

Peak flow: the maximum instantaneous value of discharge over a specified period of time

Pier: on bridges of more than one span, the intermediate supports between abutments

Pipe arch: a type of culvert with a shape of greater span than the rise, an arch-shaped top and a curved integral bottom

Pools: depressions in a bed of a watercourse, frequently a resting place for fish

R5 rip-rap: solid, well-mixed rock containing approximately the following size distribution: 100% <220 millimetres, 70-90% <190 millimetres, 40-55% < 150 millimetres, 0-15% <70 millimetres in approximate diameter

R25 rip-rap: solid, well-mixed rock containing approximately the following size distribution: 100% <380 millimetres, 70-90% <330 millimetres, 40-55% < 260 millimetres, 0-15% <120 millimetres in approximate diameter

Riffle: shallow water extending across the bed of a flowing watercourse with rapid current and with surface flow broken into waves by submerged obstructions such as gravel and cobble

Right-of-way: the width and length of the cleared area along the road alignment which contains the roadbed, ditches, fore and backslopes

Rise: the distance from the bed of the watercourse to the underside of the stringers of a bridge, or the vertical dimension of an arched pipe

Sand: loose mineral and rock particles ranging in diameter from 0.02-2 millimetre

Scour: an erosion process resulting in the abrading of the bed of a watercourse or the undermining of a foundation by the action of flowing water/ice

Sedimentation: the deposition of fine particles, such as sand, silt, and clay, which have been eroded from exposed soils and transported by water

Settling pond: artificial ponds designed to collect suspended sediment and separate suspended particles from water by gravity settling

Sheet flow: the overland flow of surface runoff over a relatively smooth land surface in the form of a continuous thin film that is not concentrated in channels larger than rills

Shoulder of the bank of the watercourse: the point in the bank of a watercourse where the sharpest break in slope occurs, and the steep sides slope down to meet the exposed mineral bed of the watercourse

Silt fence: specially designed synthetic fabrics fastened on supporting posts which are designed to efficiently control and trap sediment runoff from construction sites

Skidding: the short-distance movement of tree lengths or segments over unimproved terrain to loading points on transportation routes

Sorbent material: material that has the capacity to absorb another substance

Span: the horizontal distance between the interior face of the abutments/supports of a bridge

Stream morphology: shape of a watercourse channel and how it changes in shape and direction over time

Stripping: the removal of organic material and mineral soil that is unsuitable for creating a roadbed

Subgrade: the bed of ground on which the foundations of a road are laid

Substrate: the materials making up the bed of the watercourse

Terracing: construction of an embankment or combination of embankment and channel across a slope at a suitable spacing to control erosion by diverting or storing surface runoff instead of permitting it to flow uninterrupted down the slope

Thalweg: the line defining the lowest points along the length of a river bed or valley; the lowest channel of flow within a watercourse; the “current”

Turnout: a section where a narrow roadway is broader, allowing vehicles to pass each other, pull over, or park

Upstream: towards the sources or against the current of a watercourse

Watercourse (legal): the full width and length, including the bed, banks, sides and shoreline, or any part, of a river, creek, stream, spring, brook, lake, pond, reservoir, canal, ditch or other natural or artificial channel open to the atmosphere, the primary function of which is the conveyance or containment of water whether the flow be continuous or not

Watercourse or Wetland Alteration (legal): Any temporary or permanent change made at, near or to a watercourse or wetland or to the water flow in a watercourse or wetland and includes:

- Any change made to existing structures in a watercourse or wetland including repairs, modifications or removal, whether the water flow in the watercourse or wetland is altered or not.
- The operation of machinery on the bed of the watercourse other than at a recognized fording place or in or on a wetland.
- Any deposit or removal of sand, gravel, rock, topsoil or other material into or from a watercourse or wetland or within 30 m of a wetland or the bank of a watercourse.
- Disturbance of the ground within 30 m of a wetland or a bank of a watercourse except grazing by animals; the tilling, ploughing, seeding, and harrowing of land; the harvesting of vegetables, flowers, grains, and ornamental shrubs; and any

other agricultural activity prescribed by regulation that occurs more than 5 m from a wetland or the bank of a watercourse.

- Any removal of vegetation from the bed or bank of a watercourse.
- Any removal of trees from within 30 m of the bank of a watercourse.
- Any removal of vegetation from a wetland or from within 30 m of a wetland except the harvesting of vegetables, flowers, grains and ornamental shrubs and any other agricultural activity prescribed by regulation that occur more than 5 m from a wetland.

Watercourse and wetland alteration permit: a permit signed by the minister of the Department of Environment and Local Government and issued according to the *Watercourse and Wetland Alteration Regulation*

Waterway opening: the cross-sectional area under a bridge available for the passage of water, also known as “end area

Wetland (legal): land that either periodically or permanently, has a water table at, near or above the land’s surface or that is saturated with water, and sustains aquatic processes as indicated by the presence of hydric soils, hydrophytic vegetation and biological activities adapted to wet conditions. These lands are transitional between terrestrial and aquatic systems

Wingwall: a lateral wall built onto an abutment serving to retain earth in the embankment

13.0 REFERENCES OF DOCUMENTS

- Adamson, B. and A. Harris. 1992. *Sediment Control Plans: Reducing Sediment Concerns at Water Crossings*. Northwestern Ontario Forest Technology Development Unit, Tech. Note TN-20.
- Ammand, A. and A. L. Stone. 1991. *Method for the Comparative Evaluation of Nontidal Wetlands in New Hampshire. Appendix E: Interpretation of Topographic Maps and Watershed Delineation Procedures*. New Hampshire Department of Environmental Services, Concord, NH.
- Atlantic Industries Limited. Sales Pamphlets. Corrugated Steel Pipe; Bolt-A-Bin; Bolt-A-Plate.
- Atlantic Industries Limited. Personal Communication. Roger Leger, CET, Maritime Sales Manager.
- Blinn, C.R., et al. 1998. *Temporary Stream and Wetland Crossing Options for Forest Management*. United States Department of Agriculture Forest Service, North Central Research Station, General Technical Report NC-202.
- Braithwaite, G.C., P. Eng. 1992. *Woodlot Roads Stream Crossings*. Cooperation for Forestry Development, Nova Scotia
- Department of Fisheries and Oceans. 1999. *Fact Sheets Prepared by Habitat*.
- Douglas, Robert A. August 1999. *Planning When Constructing Forest Roads and Stream Crossings*, University of New Brunswick. Workshop Proceedings "Maintaining Water Quality in Woodlands Operations". Atlantic Branch of the Canadian Woodlands Forum.
- Government of British Columbia. October 1996. Forest Practices Code. *Community Watershed Guidebook*.
- Government of British Columbia. April 22, 2002. Forest Practices Code: *Forest Road Engineering Guidebook*.
- Government of British Columbia. Forest Practices Code: *Fish Stream Crossing Guidebook*.
- Government of Newfoundland and Labrador, Department of Environment. May 1986. Chapter 3: *Environmental Guidelines for Watercourse Crossings*. Water Resources Division, Water Investigations Branch.

Government of Newfoundland and Labrador, Department of Environment and Lands. January 1989. Chapter 4: *Environmental Guidelines for Bridges*. Water Resources Division, Water Investigations Branch.

Harland, J.A. and D.H. Waller. 1996. *Planning for Erosion and Sediment Control*. Centre for Water Resources Studies, CWRS Internal Report No. 96-2.

J.D. Irving, Limited. Personal Communication. Mike Boyd.

Johnson Levels Inc. – Product Information

<http://www.johnsonlevel.com>

Maine Department of Environmental Protection. March 1991. *Maine Erosion and Sediment Control Handbook for Construction: Best Management Practices*.

Mead New England Forest Resources Group. *Best Management Practices for Erosion Control & Water Quality Protection in Northern New England Forestry Operations*. Mead, Paper Division, Maine.

New Brunswick Department of Environment and Local Government. May 2012. *Watercourse and Wetland Alteration Technical Guidelines*.

<https://www2.gnb.ca/content/dam/gnb/Departments/env/pdf/Water-Eau/WatercourseWetlandAlterationTechnicalGuidelines.pdf>

New Brunswick Department of Justice. Acts and Regulations.

<http://www.gnb.ca/justice/asrlste.htm>

New Brunswick Department of Natural Resources and Energy / Department of Environment and Local Government. December 2001. *Proposed Provincial Wetlands Conservation Policy*.

New Brunswick Department of Natural Resources and Energy. May 1994. *Forest Management Manual for Crown Lands*.

New Brunswick Department of Natural Resources and Energy. July 2000. *Nuisance Wildlife Policy, Appendix B*.

New Brunswick Department of Natural Resources and Energy. Forest Extensions Branch. *Environmental Guidelines Manual for Watercourse Alterations on Private Woodlots*.

New Brunswick Department of Natural Resources and Energy. Forest Extensions Branch. Module 13, *Private Woodlots and the Clean Water Act*.

New Brunswick Department of Transportation. August 1998. *Environmental Field Guide*.

New Brunswick Department of Transportation. May 1998. *Environmental Protection Plan for New Brunswick Department of Transportation.*

New Brunswick Department of Transportation. Personal Communication. Phil Hanson.

New Brunswick Power Corporation Environmental Affairs. December 2001. *Environmental Protection Plan for New Brunswick Power Corporation Transmission Facilities.*

Newfoundland and Labrador Department of Fisheries and Oceans. March 1998. *Guidelines for Protection of Freshwater Fish Habitat in Newfoundland and Labrador.*

North Carolina Forest Services. Division of Forest Resources. *Minimizing Water Quality Impacts During Forest Harvest Operations.*

Nova Scotia Department of Environment, Environmental Assessment Division. April 1989. *Environmental and Sedimentation Control Handbook for Construction Sites: Section 2- Erosion and Sediment Control Fact Sheets.*

Ontario Ministry of Natural Resources. 1990. Queen's Printer for Ontario. *Environmental Guidelines for Access Roads and Water Crossings.*

Prince Edward Island Department of Transportation and Public Works. April 1993. *Environmental Practices for Highway Construction and Maintenance.*

Richard L. 1998. *A Landowner's Guide to Building Forest Access Roads.* United States Department of Agriculture Forest Service, Northeastern Area Technical Report: NA-TP-06-98.

South Carolina Forestry Commission. *Best Management Practices: Forest Road Construction.*

University of Minnesota, Extension Service. 1998. *Forest Management Practices Fact Sheet Crossing Options Series #5: Timber Bridges.* FS-7005-GO

Walker, D and Entine, L. 2002. *BASIC Surveying Manual.* Wisconsin Transportation Information Center (LTAP).
<https://ctt.mtu.edu/sites/default/files/flyers/Surveying%20manual.pdf>

Ward, N. 1992. *The Problem of Sediment in Water for Fish.* Ontario Ministry of Natural Resources. Northwestern Ontario Forest Management Technical Development Unit, Tech. Notes TN-21.

APPENDICES

APPENDIX A: WATERCOURSE ALTERATION CERTIFICATION DATA SHEET ii
APPENDIX B: WETLAND IDENTIFICATION DATA SHEET vi
APPENDIX C: WATERCOURSE IDENTIFICATION DATA SHEET vii
APPENDIX D: DIRECTORY viii

APPENDIX A: WATERCOURSE ALTERATION CERTIFICATION DATA SHEET

1. General Information

Site coordinates: Lat. _____ Long. _____

Property is listed under my name (or my organization): Yes No

If no, I have attached a consent letter to my application: Yes No

Certified designer responsible for calculations: _____
(for watercourse crossings + water withdrawals)

Certified designer responsible for onsite work: _____

OR

Certified installer responsible for onsite work: _____
(if different than certified designer listed above)

Will the project result in a new footprint (beyond the toe of slope of an existing structure) greater than 100 m²?

Yes No

2. Type of Work

Also see the corresponding section indicated in ()

- Bank stabilization (biotechnical/rip-rap) ([Section 1](#))
- Beaver dam management and removal
- Bridge (permanent) – new/replacement of a single span ([Section 2](#))
- Bridge – maintenance
- Bridge removal
- Culvert – new/replacement ([Section 3](#))
- Culvert – extending an existing ([Section 4](#))
- Culvert maintenance
- Culvert removal
- Temporary bridge
- Timber harvesting ([Section 5](#))
- Removal of non-merchantable woody vegetation ([Section 6](#))
- Water withdrawal ([Section 7](#))

Section 1: Bank stabilization (biotechnical/rip-rap)

Check one:

- Biotechnical
- Rip-rap/armor stone

Height of product to be placed on the bank: _____

Length of product to be placed on the bank: _____

The following information is required for review:

- Scaled drawings (plan and cross-section) that clearly show all dimensions of the project (size of rock to be used, bank length of project, bank height of project, proposed slope of the bank, location of rock toe)
- Photos of the bank where the erosion protection products are to be placed (clearly labelled: looking upstream, looking downstream, looking directly forward)
- If vegetation is to be removed along or on top of the bank to facilitate the placement of rock and/or machinery access, a revegetation plan must be prepared and submitted

Section 2: Bridge (permanent) – new/replacement of a single span

Upstream drainage area (km²): _____

Waterway opening (m²): _____
(end area)

Height of true right bank (looking downstream): _____

Height of true left bank (looking downstream): _____

Section 3: Culvert – new/replacement

Bankfull width of channel (m): _____

Height of true right bank (looking downstream): _____

Height of true left bank (looking downstream): _____

Upstream drainage area (km²): _____

Diameter (mm): _____

Span (m): _____
(for open-bottom culvert)

Length (m): _____

Pipe material: _____

Is this a new watercourse crossing or a replacement?

- New crossing
- Crossing replacement*

***Please provide the following information for a crossing replacement:**

Is the current crossing open or closed bottom: _____

What is the diameter or span of the current crossing (mm): _____

Check one:

- Open-bottom culvert
- Closed-bottom culvert watercourse slope 0.5% or less (requires cross-section drawing clearly showing slope of watercourse and details of proposed culvert)
- Closed-bottom culvert watercourse slope 0.5% to 5.0%*
- Twin-pipes*
- Stream simulation culvert*

***The following information is required for review:**

- Clearly labelled upstream and downstream photos of the crossing site; typical habitat photos upstream and downstream of the crossing site
- Plan and profile (cross-section) drawings. Should also show the stream survey including slope, downstream, and upstream control riffle elevation (thalweg)
- For culverts with baffles: baffle height, notch width, notch depth, drop between baffles
- Energy dissipation pool width, length, depth
- Rock size and mix for stream bed
- For project where water control measures are anticipated to be in place for more than 3 weeks: a water control plan including how long expected to be in place and details on how fish passage is to be provided

NOTES													
Riffle:	Shallow water extending across the bed of a flowing watercourse with rapid current and surface flow broken into waves by submerged obstructions such as gravel and cobble.												
Downstream Riffle:	Look for the location of the highest streambed elevation between 3-D and 10-D downstream. Take the elevation of the bottom of the wet width channel at this point. (Thalweg)												
Upstream Riffle :	Look for the location of the highest streambed elevation within 10-D upstream. Take the elevation of the bottom of the wet width channel at this point. (Thalweg)												
UPSTREAM	DOWNSTREAM												
WATERCOURSE SLOPE	PIPE STRUCTURE SLOPE												
(A) _____ m - (B) _____ m RISE = _____ m	RISE = _____ m + (L4) _____ m _____ m X 100 = _____ %												
(C) _____ m - (E) _____ m RISE = _____ m	RISE = _____ m + (L2) _____ m _____ m X 100 = _____ %												
	<table border="1" style="width:100%; border-collapse: collapse;"> <tr> <td colspan="2" style="text-align: center;">EXISTING CONDITIONS</td> <td style="text-align: center;">Calculation by :</td> <td style="text-align: center;">Date :</td> </tr> <tr> <td colspan="2">Project Name :</td> <td>Route No. :</td> <td>Appel No. :</td> </tr> <tr> <td colspan="2">Location :</td> <td>District Office :</td> <td>Drawing No. :</td> </tr> </table>	EXISTING CONDITIONS		Calculation by :	Date :	Project Name :		Route No. :	Appel No. :	Location :		District Office :	Drawing No. :
EXISTING CONDITIONS		Calculation by :	Date :										
Project Name :		Route No. :	Appel No. :										
Location :		District Office :	Drawing No. :										

Section 4: Culvert – extending an existing

Original pipe length (m): _____

Final pipe length (m): _____

Total footprint of culvert and altered streambed (including energy dissipation pool – if included in the design) (m²): _____

Section 5: Timber harvesting

PID(s) where harvesting is to take place: _____

Section 6: Removal of non-merchantable woody vegetation

PID(s) where harvesting is to take place: _____

A fully dimensioned sketch showing the scope and location of the proposed vegetation removal must be included for review.

Section 7: Water withdrawal

Upstream drainage area (km²): _____

Maximum pumping rate (litres/minute): _____

APPENDIX B: WETLAND IDENTIFICATION DATA SHEET

Note: This data sheet must be filled out by someone qualified, meaning a person having a combination of training in wetland identification and delineation based on the North-Central and Northeast Regional Supplement of the U.S. Army Corps of Engineers Wetlands Delineation Manual (1987) or an equivalent pending review from the Source and Surface Water Management Branch and; education and/or demonstrated experience in wetland hydrology, soils, botany and/or related sciences.

DELG Wetland Identification Data Sheet	
Project/Site:	
Site Visit Date:	
Investigator(s):	
PID:	GPS Coordinate:
Wetland Type (circle or highlight):	
<div style="display: flex; justify-content: space-between; text-align: center;"> Forested Riparian Shrub Fen/Bog Marsh Aquatic Bed </div>	
Wetland Hydrology and Connectivity:	
Dominant Wetland Vegetation (3 species minimum):	
Dominant Upland Vegetation:	
Wetland Soil Description:	
Upland Soil Description:	
Additional Information (include photos and wetland limit on aerial imagery and/or site plans):	

APPENDIX C: WATERCOURSE IDENTIFICATION DATA SHEET

Site Visit Date: _____

Carried out by: _____

PID: _____

Latitude: _____ Longitude: _____

Station #	Transect Distance (m)	Bank Width (cm)	Meets Definition? *>0.5 m/ rock, soil substrate/defined channel
1			
2			
3			
4			
5			
6			
7			
8			
9			
10			
Average width			

Notes: _____

Requirements

- A minimum of five width measurements must be taken upstream at representative areas of the natural stream, from the top of both stream banks. Dependant on length of stream these can be taken at 5-metre increments of greater or less depending on site specific information.
- If not possible, then measurements should be taken immediately after the crossing site downstream at representative areas.

SECTION LOCATION

Take measurements between 20 and 30 meters below the culvert outlet

MEASUREMENTS

Height of the left bank (Looking Downstream) _____ m
 Height of the right bank (Looking Downstream) _____ m
 Distance between the shoulders of the banks (Bank full width) _____ m

	WATERCOURSE CROSS SECTION		Measurements by :	Date :
	Project Name :		Route No. :	Asset No. :
	Location :		District Office :	Drawing No. :

Drawn by: RSC, Modified: G. Kelly, 08/2011

APPENDIX D: DIRECTORY

NEW BRUNSWICK DEPARTMENT OF ENVIRONMENT AND LOCAL GOVERNMENT (DELG)

CENTRAL OFFICE

Fredericton	Marysville Place 20 McGloin St. Fredericton, NB, E3A 5T8	Phone (506) 457-4850 Email wawa@gnb.ca
--------------------	--	--

REGIONAL OFFICES

Bathurst	Regional Operations & Compliance 159 Main St., Suite 202 Bathurst, NB E2A 1A6	Phone (506) 547-2092 Fax (506) 547-7655
-----------------	---	--

Fredericton	Regional Operations & Compliance 20 McGloin St. Fredericton, NB E3A 5T8	Phone (506) 444-5149 Fax (506) 453-2893
--------------------	---	--

Miramichi	Regional Operations & Compliance 316 Dalton Avenue Miramichi, NB E1V 3N9	Phone (506) 778-6032 Fax (506) 778-6796
------------------	--	--

Moncton	Regional Operations & Compliance 355 Dieppe Blvd Moncton, NB E1A 8L5	Phone (506) 856-2374 Fax (506) 856-2370
----------------	--	--

Saint John	Regional Operations & Compliance 8 Castle Street Saint John, NB E2L 3B8	Phone (506) 658-2558 Fax (506) 658-3046
-------------------	---	--

Grand Falls	Regional Operations & Compliance 65 Broadway Blvd Grand Falls, NB E3Z 2J6	Phone (506) 473-7744 Fax (506) 475-2510
--------------------	---	--

ENVIRONMENT EMERGENCY

National Environmental Emergencies Center

1-800-565-1633 (24 hours/day)

NEW BRUNSWICK DEPARTMENT OF NATURAL RESOURCES AND ENERGY DEVELOPMENT (DNRED)

CENTRAL OFFICE

Fredericton	New Brunswick Department of Natural Resources and Energy Development (1350 Regent Street, E3C 2G6) P.O. Box 6000 Fredericton, NB E3B 5H1	Phone (506) 453-3826 Fax (506) 444-4367
--------------------	---	--

REGIONAL OFFICES

Bathurst (Region 1)	New Brunswick Department of Natural Resources and Energy Development 2570 Route 180 South Tetagouche, NB E2A 7B8	Phone (506) 547-2080 Fax (506) 547-2068
--------------------------------	--	--

Miramichi (Region 2)	New Brunswick Department of Natural Resources and Energy Development 80 Pleasant Street Miramichi, NB E1V 1X7	Phone (506) 627-4049 Fax (506) 627-4224
---------------------------------	---	--

Fredericton (Region 3)	New Brunswick Department of Natural Resources and Energy Development Fredericton HQ – Ancillary Building 1350 Regent Street Fredericton, NB E3C 2G6	Phone (506) 444-4888 Fax (506) 453-5237
-----------------------------------	--	--

Edmundston (Region 4)	New Brunswick Department of Natural Resources and Energy Development 25 Guy Street Edmundston, NB E3V 3K5	Phone (506) 735-2040 Fax (506) 735-2042
----------------------------------	---	--

FISHERIES AND OCEANS CANADA (DFO)

Gulf Region	Fish and Fish Habitat Protection Program Fisheries and Oceans Canada 343 University Avenue Moncton, NB E1C 9B6	Phone (506) 851-6082 Email xqlf-habitat2@dfo-mpo.gc.ca
--------------------	---	--